

WELCOME TO THE ULTIMATE HOT TUB EXPERIENCE!

We sincerely hope your spa life is a pleasant experience. If problems should arise, contact your authorized Marquis® dealer. Or contact Marquis Corp. at any of the following:

Email: service@marquiscorp.com
Web: www.marquisspas.com
Marquis Corp.
596 Hoffman Road
Independence, OR 97351, USA

This manual is provided to enhance your enjoyment of your spa and to prevent non-warranty situations. It is your sole responsibility to read, understand and comply with the instructions in the owner's manual. Please save your original sales receipt for reference in case of a future warranty claim. Failure to use, maintain or install the spa in compliance with this owner's manual could result in loss of warranty coverage.

SERIAL NUMBER LOCATION

You will find the serial number on the tag in the equipment area.

PLEASE FILL OUT AND KEEP FOR FUTURE REFERENCE

Name of Purchaser _____

Date of Purchase _____

Address _____

City _____ State _____ Zip Code _____

Telephone _____

Spa Model/Color _____

Spa Serial # _____

Pack Serial # _____

Dealer's Name _____

Dealer's Address _____

City _____ State _____ Zip Code _____

Telephone _____

Every effort has been made to ensure the accuracy of this manual. However, Marquis® reserves the right to improve its product without notice. This could create a minor variation between this manual and the actual product you receive. We apologize for any inconvenience this may cause.



- **IMPORTANT SAFETY INSTRUCTIONS**
 - 120V, Cord Connected Models 3
 - 240V, Permanently Installed or Converted Models 4
 - All Spa Models 4-7
 - Personal Safety 7-8

- **INSTALLATION INSTRUCTIONS**
 - Location 8-9
 - Filter Cartridges 10
 - Electrical Requirements 11-13

- **STARTING YOUR HOT TUB**..... 13-15

- **VECTOR21 HOT TUB MODELS**
 - V65L.....16-17
 - V77L 18-20
 - V84 21-23
 - V84L 24-25
 - V94..... 26-27
 - V94L..... 28-39

- **VECTOR21 SPA CONTROL OPERATION**
 - All Models..... 30-32
 - Cosmic Audio System..... 33
 - Wi-Fi..... 33
 - MicroSilk®..... 34

- **VECTOR21 EQUIPMENT DIAGRAMS**
 - V65L..... 35
 - V77L..... 36-37
 - V84, V84L..... 38-39
 - V94, V94L..... 40

- **VECTOR21 TROUBLESHOOTING**
 - LCD Diagnostic Messages..... 41-42

- **MAINTENANCE** 43-47

- **SPA CARE AND ENJOYMENT GUIDE**..... 48-53

- **WATER TROUBLESHOOTING**..... 54-55

- **STEP ASSEMBLY INSTRUCTIONS**..... 56

- **VECTOR21 OWNER'S PROTECTION PLAN**..... 57-60

The following instructions contain important safety information. We strongly encourage you to read and apply them.

IMPORTANT SAFETY INSTRUCTIONS

WHEN INSTALLING AND USING THIS ELECTRICAL EQUIPMENT, BASIC SAFETY PRECAUTIONS SHOULD ALWAYS BE FOLLOWED, INCLUDING THE FOLLOWING:

1. READ AND FOLLOW ALL INSTRUCTIONS

2. **WARNING:** To reduce the risk of injury, do not permit children to use this product unless closely supervised at all times.
3. **DANGER: RISK OF CHILD DROWNING.** Extreme caution must be exercised to prevent unauthorized access by children. To avoid accidents, ensure that children cannot use the spa or hot tub unless they are supervised at all times.

120 VOLT, CORD CONNECTED MODELS

4. **DANGER: RISK OF INJURY.** Connect only to a grounded source.
5. Do not bury the power cord.
6. **WARNING:** To reduce the risk of electric shock, replace a damaged cord immediately.
7. A ground terminal (pressure wire connector) is provided on the surface of the control box inside the equipment compartment. This connector should be bonded with a minimum No. 8 AWG (8.42mm²) (No. 6 AWG in Canada) solid copper wire between this unit and any metal ladders, metal water pipes, metal enclosures of electrical equipment, conduit, or metal equipment within five feet (1.52m) of the spa. If the spa is located on a reinforced concrete pad, the reinforcing steel should also be bonded to the ground terminal.
8. **WARNING:** Your spa may be equipped with a Ground Fault Circuit Interrupter (GFCI) on the end of the power supply cord. Before each use of the spa, with the plug connected to the power supply and the unit operating, press the "test" button. The unit should stop operating and the GFCI power indicator will go out. Wait thirty seconds and then reset the GFCI by pressing the "Reset" button. The GFCI power indicator will turn on, restoring power to the spa. If the interrupter does not perform in this manner, it is an indication of an electrical malfunction and the possibility of an electric shock. Disconnect the plug from the receptacle until the fault has been identified and corrected.



240 VOLT, PERMANENTLY INSTALLED OR CONVERTED MODELS

9. A ground terminal is provided on the control box. To reduce the risk of electric shock, connect this terminal to the grounding terminal of your electrical service or supply panel with a continuous green, insulated copper wire. The wire must be equivalent in size to the circuit conductors supplying the equipment. In addition, a bonding terminal (pressure wire connector) is provided on the outside of the control box for bonding to local ground points. To reduce the risk of electric shock, this connector should be bonded with a No. 8 AWG (8.42mm²) (No. 6 AWG in Canada) solid copper wire to any metal ladders, water pipes, or other metal within five feet (1.52m) of the spa to comply with local requirements.
10. Your spa uses ground fault circuit interrupters in the electrical sub-panel. Before each use of the spa and with the unit operating press the Test button on each breaker. The switch should click over to the "Trip" position. Wait thirty seconds and reset each GFCI breaker by switching it completely off and then completely on. The switch should then stay on. If either of the interrupters does not perform in this manner, it is an indication of an electrical malfunction and the possibility of an electric shock. Disconnect the power until the fault has been identified and corrected.

ALL SPA MODELS

11. Install the spa so proper drainage is provided.
12. **DANGER: RISK OF ELECTRIC SHOCK.** Install the spa at least five feet (1.52m) away from metal surfaces, in accordance with the National Electric Code ANS/NMFA70-1993. Each metal surface must be permanently connected to a minimum No. 8 (8.42mm²) (No. 6 AWG in Canada) solid copper conductor attached to the wire bonding connector on the terminal box provided for this purpose.
13. **DANGER: RISK OF ELECTRIC SHOCK.** Do not permit any appliance, such as a light, telephone, radio, or television, etc. within five feet (1.52m) of the spa or hot tub.
14. **WARNING:** To reduce the risk of injury:
 - Water temperatures between 100°F (38°C) and 104°F (40°C) are considered safe for a healthy adult. Lower water temperatures are recommended for extended use (exceeding 10 minutes) and for young children.
 - Since excessive water temperatures have a high potential for causing fetal damage during the early months of pregnancy, pregnant or possibly pregnant women should limit spa water temperatures to 100°F (38°C).
 - Before entering a spa, the user should measure the water temperature with an accurate, waterproof, fever thermometer since the tolerance of temperature-regulating devices may vary as much as +/- 5°F (3°C).
 - The use of drugs, alcohol, or medication before or during spa use may lead to unconsciousness with the possibility of drowning.
 - Persons suffering from obesity or with a medical history of heart disease, low or high blood pressure, circulatory system problems, or diabetes should consult a physician before using the spa.

- Persons using medications should consult a physician before using a spa since some medication may induce drowsiness while other medication may affect heart rate, blood pressure, and circulation.
15. **DANGER: TO REDUCE THE RISK OF INJURY TO PERSONS.** Do not remove the suction fittings.
 16. **DANGER: RISK OF INJURY:** Never operate a spa if the suction guard(s) is broken or missing. Never replace a suction guard with one rated less than the flow rate marked on the original suction guard. The suction guard(s) in the spa are sized to match the specific water flow created by the pump. Should the need arise to replace the suction guard(s) or the pump, be sure that the flow rates are compatible.
 17. **DANGER:** Children are especially sensitive to hot water. At no time should children have unsupervised access to the spa. Children must not be allowed to climb onto the spa cover. All Marquis spas are equipped with a locking cover that meets the ASTM F1346-91 Standard for Safety Covers. Always lock the child resistant locks after using the spa for your children's safety.

18. **SAVE THESE INSTRUCTIONS.**

WARNING: Do not permit electric appliances (such as a light, telephone, radio, or television) within five feet (1.52m) of the spa or hot tub.

WARNING: Children should not use spas or hot tubs without adult supervision.

WARNING: Do not use spas or hot tubs unless all suction guard(s) are installed to prevent body and hair entrapment.

WARNING: Do not use drugs or alcohol before or during the use of a spa or hot tub to avoid unconsciousness and possible drowning.

WARNING: People using medications and/or having an adverse medical history should consult a physician before using a spa.

WARNING: The use of alcohol, drugs, and medication can greatly increase the risk of fatal hyperthermia.

WARNING: Before entering the spa or hot tub measure the water temperature with an accurate thermometer.

WARNING: Water temperature in excess of 104°F (40°C) may be injurious to your health.

WARNING: Prolonged immersion in a spa or hot tub may be injurious to your health.

WARNING: People with infectious diseases should not use a spa.

WARNING: Pregnant or possibly pregnant women should consult a physician before using a spa or hot tub.

WARNING: To avoid injury, exercise care when entering and exiting the spa or hot tub.

WARNING: Do not use a spa or hot tub immediately following strenuous exercise.

WARNING: Maintain water chemistry in accordance with manufacturer's instructions.

SAFETY INSTRUCTIONS FOR FRENCH SPEAKING SPA OWNERS

AVERTISSEMENT: Ne pas placer d'appareil électrique (luminaire, téléphone, radio, téléviseur, etc.) moins de 1.52 m de cette cuve de relaxation.

AVERTISSEMENT: Ne pas laisser les enfants utiliser une cuve de relaxation sans surveillance.

AVERTISSEMENT: Pour éviter que les cheveux ou une partie du corps puissent être aspirés, ne pas utiliser une cuve de relaxation si les grilles de prise d'aspiration ne sont pas toutes en place.

AVERTISSEMENT: Pour éviter l'évanouissement et la noyade éventuelle, ne prendre ni drogue ni alcool avant d'utiliser une cuve de relaxation ni quand on s'y trouve.

AVERTISSEMENT: Les personnes qui prennent des médicaments ou ont des problèmes de santé devraient consulter un médecin avant d'utiliser une cuve de relaxation.

AVERTISSEMENT: La consommation d'alcool ou de drogue augmente considérablement les risques d'hyperthermie motrice dans une cuve de relaxation.

AVERTISSEMENT: Avant d'utiliser une cuve de relaxation mesurer la température de l'eau l'aide d'un thermomètre précis.

AVERTISSEMENT: Il peut être dangereux pour la santé de se plonger dans de l'eau plus de 40°C.

AVERTISSEMENT: L'utilisation prolongée d'une cuve de relaxation peut être dangereuse pour la santé.

AVERTISSEMENT: Les personnes atteintes de maladies infectieuses ne devraient pas utiliser une cuve de relaxation.

AVERTISSEMENT: Les femmes enceintes, que leur grossesse soit confirmée ou non, devraient consulter un médecin avant d'utiliser une cuve de relaxation.

AVERTISSEMENT: Pour éviter des blessures, user de prudence en entrant dans une cuve de relaxation et en sortant.

AVERTISSEMENT: Ne pas utiliser une cuve de relaxation immédiatement après un exercice fatigant.

ATTENTION: La teneur de l'eau en matières dissoutes doit être conforme aux directives du fabricant.

PERSONAL SAFETY

Prolonged immersion in hot water can result in **HYPERTHERMIA**, a dangerous condition which occurs when the internal temperature of the body reaches a level above normal (98.6°F, 37°C). The symptoms of hyperthermia include dizziness, fainting, drowsiness, lethargy, and a body temperature above 98.6°F (37°C). The physical effects of hyperthermia include unawareness of impending hazard, failure to perceive heat, failure to recognize the need to exit the spa, physical inability to exit the spa, fetal damage in pregnant women, and unconsciousness resulting in a danger of drowning.



Other booklets about spa safety are: “Children Aren’t Waterproof,” “Pool and Spa Emergency Procedures For Infants and Children,” “Layers of Protection” and “The Sensible Way to Enjoy Your Spa” published by Association of Pool & Spa Professionals.

WARNING: The use of alcohol, drugs, or medication can greatly increase the risk of fatal hyperthermia in hot tubs and spas.

Persons taking medications which induce drowsiness such as tranquilizers, antihistamines, or anticoagulants should not use the spa. Pregnant women and persons with a medical history of heart disease, diabetes, or high blood pressure should consult a physician before using the spa.

PERSONAL SAFETY DOs:

- Be sure your spa is connected to the power supply correctly – only use a licensed electrical contractor.
- Shut off power supply (unplug 120V models) before draining the spa or servicing the electrical components.
- Test the Ground Fault Circuit Interrupter (GFCI) monthly.
- Always test the water temperature with an accurate thermometer before entering the spa to be sure that it’s a safe temperature.
- Do not use the spa if water temperature is outside of set temperature.
- Remember that wet surfaces can be very slippery. Take care when entering and exiting the spa.
- Lock the DuraCover™ when the spa is not in use, whether it is empty or full of water.
- Keep the water clean and sanitized with correct chemical care.
- Turn on the jets when adding ANY chemicals to the spa water.
- Clean the filter cartridge(s) monthly to remove debris and mineral buildup which affects the performance of the hydrotherapy jets, limits the flow, or trips the high limit thermostat which will turn off the entire spa.

PERSONAL SAFETY DO NOTs:

- Don’t use the spa with the equipment compartment door removed.
- Don’t use the spa for more than 10 minutes of time at water temperatures in excess of 104°F (39°C).
- Don’t allow the jet pump(s) to operate for an extended period of time with the cover in place. Extended pump operation causes a slow heat buildup due to water friction. The spa equipment controls are equipped with a built-in safety timer that automatically shuts off the jet pump(s) after 15 minutes of continuous operation should it have been left on inadvertently.
- Don’t operate the spa at any time with the filter cartridges removed.
- Don’t lift or drag the cover by using the tie-down straps; always lift and carry by using the external handles.
- Don’t store chemicals in the spa’s equipment compartment.
- Don’t hesitate to call your authorized dealer with any questions or maintenance concerns.

LOCATION

For your portable spa to function properly and safely, it must be located on a hard, flat, level surface. Inground spas require special installation techniques and should be planned in conjunction with your authorized Marquis® Dealer. Improper installation can result in structural damage to the spa and the voiding of your spa warranty. Items to discuss with your dealer include: Local construction codes, electrical service requirements, serviceability of equipment, present underground obstructions such as gas, water, and telephone lines, safety measures such as fences and locks, and visibility of the spa installation from the home, street, and neighbors.

Do not shim your spa. If your pad is not level you must pour a top cap: contact a professional.

- Allow for sufficient water drainage around the spa to help preserve the equipment and support structure. This includes indoor installations.
- A filled spa can weigh up to 5,000 pounds and the location should support the weight of the filled spa.
- Locate the equipment compartment where it will be accessible. Your spa **MUST** be installed to permit access for servicing the equipment above and/or below any decks or floors. Access is essential and must allow adequate room for service. To facilitate repairs, Marquis Corp. or its agent may require access to spa equipment. It is your responsibility to provide unencumbered access. See spa diagrams for location of power supply.
- Leave access to the circuit breakers in the sub panel (240V models) or to the interrupter switch (GFCI, 120V models) on the end of the power cord.
- Be sure the spa is level and in the final position **BEFORE** filling with water. Check for power cords, tools, and hoses that may be caught underneath the spa. Do not apply power to the spa before it is completely filled with water. Damage to the pumps, heater and sensors may result.
- **IMPORTANT: DO NOT LET AN EMPTY SPA REMAIN EXPOSED TO DIRECT SUNLIGHT.**

Spa surface temperatures can reach in excess of 180°F (82°C) if left exposed to the sun. Significant damage can occur to the acrylic if this is allowed to happen, including warping and blistering of the surface. Damage, that occurs as a result of this exposure, is not covered under the warranty.

- **CAUTION:** Never try to move a spa that has not been fully drained. To do so could result in damage to the spa and physical injury to the mover. Cracks in the spa surface, exterior siding or base due to improper transport or support of the spa are not covered under the warranty.



OUTDOOR AND PATIO INSTALLATION

To install the spa outdoors, we recommend a reinforced concrete pad at least four inches thick. The reinforcing material should be attached to a #8 AWG bonding wire per national and local electrical code.

If you place the spa on the ground, even temporarily, place the spa empty of water on concrete pavers under the entire bottom of the spa. The concrete pavers should be a least two inches thick and level across the entire surface. The spa will inevitably settle and not remain level on this surface, thus it's important to get the spa onto a solid foundation as soon as possible.

INSTRUCTIONS FOR PREFABRICATED SPA PADS

If you are using a prefabricated spa pad for a foundation, please use the following guidelines:

1. Designate the area where the spa is to be installed. Please make sure the ground is flat and level.
2. Using 2"x 6" (51mm - 152mm) weather resistant lumber and 3" (76mm) outdoor deck screws, build a frame large enough for the prefabricated spa pad to fit inside with minimum 1" (25mm) clearance on all sides.
3. Install the frame in the area that has been leveled.
4. Using crushed gravel, fill the frame to the top.
5. Lay a straight piece of lumber across the frame and level any high spots in the gravel by pushing the straight lumber across the frame. Fill in any low areas with more gravel and re-level using the straight piece of lumber.
6. Compact the gravel to make the surface hard and flat. You may need to add more gravel to bring the level back up to the top of the frame. If so, please re-level and re-compact until you have a hard, flat level surface that is even with the top of the frame.
7. Place the prefabricated spa pad on top of the gravel. Please be careful not to disturb the hard, flat, level surface.
8. Please make sure no portion of the spa pad is sitting outside or on top of the framing.
9. Place the spa on top of the pad and fill the spa with water.

DECK INSTALLATION

Be sure the deck can support the weight of your filled spa by checking the deck's maximum load capacity. Consult a qualified building contractor or structural engineer. Minimum requirement is 100 lbs. (45 kg) per square foot.

INDOOR INSTALLATION

There are special requirements if you place your spa indoors. Flooring material must provide adequate traction when wet. Proper drainage is essential to prevent water puddling. Proper ventilation to the area is required. The addition of a ventilation system is recommended. Please see your contractor for details.



Shut-off valve in open position

SHUT-OFF VALVES

Your spa is equipped with shut-off valves (see EQUIPMENT DIAGRAM) that shut off the water flow to the equipment system for authorized Marquis® Dealer service. At times, a new spa or one that has recently been serviced, may have the shut-off valves partially closed which can restrict the water flow and hinder jet performance. Be sure the valves are fully open.

FREEZE PROTECTION

When a freeze condition is detected (which occurs when the temperature in the heater housing drops to 55°F, (13°C) the jet pump(s) is automatically activated. In areas with extremely cold winter conditions, your spa should be fine as long as it is left running at normal operating temperatures. For extra protection see your dealer for an optional freeze sensor. If you plan to turn the spa off, follow the instructions in this manual (see SUSPENDED USE OR WINTERIZING YOUR SPA).

OVERHEATING

In the case of extended hot weather, the spa water temperature may reach and maintain 104°F to 106°F (40°C to 41°C) or higher. This is due to the ambient temperature and the optional full insulation in the spa cabinet. You have the option of changing when or how long the pumps will run. See SPA CONTROL OPERATION for available options.

FILTER CARTRIDGES

Your portable spa is equipped with the Constant-Clean™ Filtration system. It features one or two Vortex filters.

NOTE: It is very important that the components of these filtration systems be installed properly in the proper part of the spa.

1. Hold the Vortex filter cartridge and center it in the opening of the filter housing.
2. Use the filter handle and turn the filter cartridge clockwise to screw it in place. (Use caution not to overtighten as damage may occur to threads and is not covered under warranty.)
3. Replace the filter cover.

SUCTION GUARDS

The suction guard(s) in the footwell of your spa is an opening through which the jet pump(s) draws water. The suction fittings have an integrated vacuum release built into them. In the event that a suction fitting gets blocked, air will be induced causing the pump to cavitate and the water flow interrupted. Once the blockage is removed, normal operation will resume. Suction fittings are equipped with a safety guard. Suction through the fittings can be strong. The safety guard(s) must remain in place and undamaged. A fitting with a damaged guard(s) can be dangerous, especially to small children or people with long hair. Should any part of the body become drawn to a fitting, turn the jet pump(s) off immediately. Long hair should be restrained. Never allow long hair to float freely in the spa. Replace any missing or damaged suction guard(s).

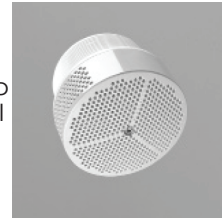

Safety guard of suction fitting must remain in place.

NOTE: It is normal for the flow rates of the suction fittings to vary from strong to barely noticeable.

ELECTRICAL REQUIREMENTS

It is the responsibility of the spa owner to ensure that all electrical connections are made by a qualified electrician in accordance with all national, state, and local electrical codes in effect at the time of installation. Fuses are covered to be free of defect at time of installation only.

NOTE: Vector21 hot tubs have different components. Please see the proper wiring in this manual.

240 Volt

All connections must be made in accordance with the wiring diagram found on the inside of the control box cover. Connections must be made with copper conductors only – *do NOT use aluminum wire*. All conductors, circuit breakers, and fuses and the GFCI must be sized in accordance to the total amperage load as specified below.

Improperly wired spas can cause irreversible damage resulting in blown fuse and melted terminal block, and to other electrical components. Also, damage caused to components or equipment caused by high or low voltage, brown outs or electric surges are not covered under warranty.

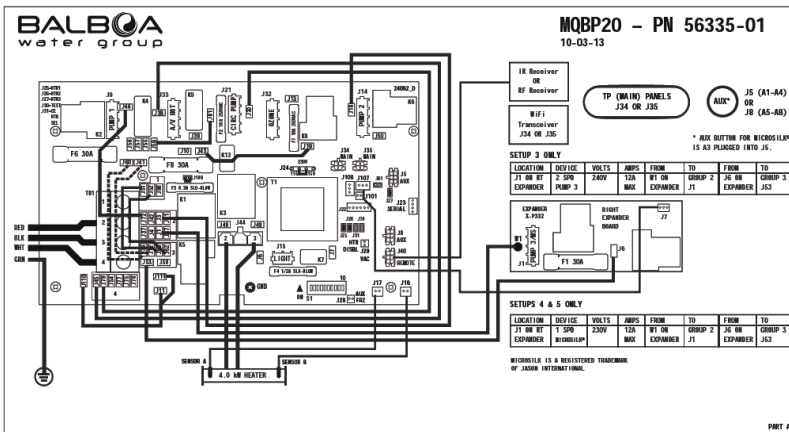

- Permanently connected (Hard wired).
- Rated 240V, 60Hz, 50A, three wires (#6 copper) plus ground (#8 copper (8.42mm²)), [4 wires total].
- Circuit breaker or fuse size: 50A.
- A disconnecting means must be installed within sight from the equipment and at least 5 feet (1.52m) from the inside walls of the spa.
- Connect only to a circuit protected by a Class A ground Fault Circuit Interrupter (GFCI).

120 Volt

120 Volt spas shall be plugged into a properly grounded, grounding type 15 amp receptacle on a dedicated circuit. A dedicated circuit is a circuit with no other components that consume power, such as lights, televisions, radios, computers, or other electronic devices. These could cause your spa to malfunction by any of the following: unusual text on the control panel, slow heating, poor jet action, tripping house breaker, or blown fuses. Failure to follow these instructions could lead to premature failure of spa components that would not be covered under the warranty. The dedicated circuit shall meet the following specifications:

- Rated 120V, 60Hz, 15A (2 wires plus ground)
- Circuit breaker or fuse size: 15A
- The receptacle must be at least 5 feet (1.52 m) from the spa.
- The 15 foot GFCI power cord provided with the spa must be plugged directly into the receptacle. Do NOT use an extension cord or any other adaptor. Actual receptacle length of cord will vary by model, but will never be less than 12 feet.

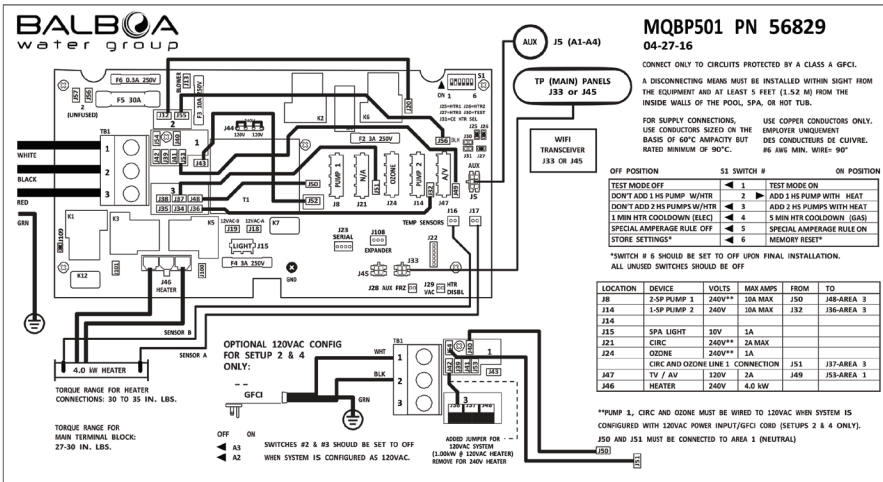

Convert 120 Volt to 240 Volt

120 Volt spas may be converted to operate on 240V, 50A. Wiring must be performed by a licensed electrician in accordance with the NEC and any local or regional electric codes.

1. Remove the GFCI cord from the terminal block on the pc board and discard.
2. Remove the white jumper wire from J42 to J38 and discard. REF FIG 1.
3. Move Dip Switch #2 up to the on position. REF FIG 2.
4. Have licensed electrician wire the spa 240V, 4-wire, 6 AWG wire on a 50-AMP GFCI breaker.

The jumpers at J44 need to stay the same and all 4-pins are covered. Reference FIG 3.

- Red (hot) wire connected to #2 on terminal block.
- Black (hot) wire connected to #3 on terminal block.
- White (neutral) wire connected to #4 on terminal block.
- Green (ground) wire routed through plastic enclosure and secured to exterior bonding lug.

Improperly wired spas are beyond Marquis Corp. control and are not covered under the warranty. Other items beyond Marquis Corp. control include, but are not limited to, damage resulting from: improper connections; accidents; failure to follow procedures and instructions defined in the Marquis® printed instructions; cleaning agents; and natural occurrences including but not limited to rodent or insect infestation, mold, lightning and other acts of nature.

STARTUP PROCEDURE

Your spa is equipped with solid-state Comfort Controls specific to your spa model. (See **SPA CONTROL OPERATION** for your specific spa model.)

NOTE: Your spa has been filled and test-run at the factory. The first time your spa is filled with water, some discoloration from residual test water may appear. This will disappear when the spa is completely filled and the filtration system is functioning.



FIG 1



FIG 2



FIG 3



Vent air by slightly opening pump unions.

THERAPY PUMP(S)

Startup procedure for all models

1. Place spa on a hard, flat, level surface. Make sure the power supply is off.
2. Make sure the suction guard(s) in the footwell are in place and undamaged.
3. Open the equipment door. Tighten all disconnects and open all shut-off valves.

NOTE: Keep the drain valve closed at all times except when draining the spa (do not rely on the cap to stop the flow of water). Not doing so could result in damage to the drain valve due to freezing water.

4. Install filter cartridges. (See **INSTALLATION INSTRUCTIONS**, Filter Cartridges.)
5. Fill the spa with water to two-thirds of the way up the Vortex skimmer openings. The use of a *Fill Filter* is recommended, especially in areas with high mineral content in the water.
6. Turn the power on.

WARNING: Spa must be completely filled with water before turning on power.

7. Your spa is now in “pump priming” mode and a “RUN PMPS PURG AIR” message displays in the LCD window of the control panel. While in this mode the spa appears idle, which lasts approximately four to five minutes if not exited manually. To exit manually, press the TEMP+/- pad.
8. Allow the spa to circulate on high-speed (see SPA CONTROL OPERATION) for four to five minutes to discharge air from the plumbing system. Do not expect hot water immediately from the jets; the heater will take several hours to heat the water.
9. At this time the spa should have water flowing from the jets. If the pump has not primed and the water is not flowing from the jets after two minutes TURN OFF POWER TO THE SPA and vent air from the pumps by slightly opening the pump unions located behind the equipment door. After turning the power on again, the spa initiates a new priming mode. Repeat steps above.
10. The system requires approximately two minutes of water flow to determine the water temperature. After two minutes of water flow, the temperature is displayed as actual water temperature. After you have manually exited the priming mode (or allowed the spa to automatically exit) the LCD window momentarily displays 100°F (38°C) and then the display switches to - - °F.
11. The factory default setting for water temperature is 100°F (38°C). Use the TEMP pad on the control panel to set the water temperature to the desired level. (See SPA CONTROL OPERATION.) It takes up to 24 hours to heat the water to desired temperature depending on the water temperature and voltage of your spa.
12. If water is not coming out of the jets, check to make sure the adjustable jets are open. Simply turn the jet face to open or close the jets.

Test the water for the proper chemical balance and adjust as necessary. SpaCare products are recommended. (See **WATER TREATMENT.**) **PROPER CHEMICAL BALANCE IS IMPORTANT** for your safety and the longevity of your spa.

DURACOVER®

When the spa is not in use, the DuraCover® should be kept on the spa to retain the water's heat and to keep out dirt, leaves, etc.

For your safety and convenience, the cover is equipped with adjustable straps, safety locks, and handles. Use the exterior handles to remove and replace your cover. Never attempt to open or remove the cover by grasping or pulling on the cover skirting or cover lock straps as the skirting may tear.

Marquis® suggests you use the safety locks to help keep out unintended users, prevent covers from being blown off in windy conditions and to maximize heat retention/energy efficiency. The cover and retractable cover system are not recommended for use in wind conditions reaching above 25 miles per hour. If your spa is located in an area susceptible to high winds, additional wind straps may be necessary to minimize cover damage.

NOTE: Marquis® exclusive DuraCover® is designed for optimum protection of the spa shell. Using an aftermarket cover will not provide the same protection and will void the shell warranty.

Open the spa cover:

1. Unfasten all cover lock straps.
2. Place one hand under the cover skirting, between the spa and cover, to break the cover's vacuum seal. Do not use cover handles to break vacuum seal.
3. Fold the front half of the cover over onto the back half.

NOTE: Unlock and release all cover locks before attempting to open cover. Damage caused by attempting to open the cover while locked or during windy conditions are not covered under warranty. Do not walk, stand, climb, or sit on the vinyl cover or retractable cover system. Do not use hard, sharp, or metal objects, such as a windshield scraper, to remove ice. Such objects can cut, mar, or puncture the cover's vinyl surface.

Close the spa cover:

1. Slide folded cover onto one half of spa.
2. Unfold the cover by lifting the handle located on the top (front) half of the cover. Allow the unfolded half to fall gently down onto the spa.
3. Secure the cover lock straps to the spa and lock them.

NOTE: When opening a cover with a cover removal mechanism, use one of the manufacturer's recommended methods. Do not attempt to open the cover in any other way. Damage caused by improper opening or closing of the cover is not covered under the warranty.

Fading, staining, torn stitching of the spa cover and broken foam cores are not covered under the warranty for any reason. Spa covers do not qualify for labor coverage under the warranty. These parts can be purchased or exchanged under warranty at your authorized Marquis® Dealer.

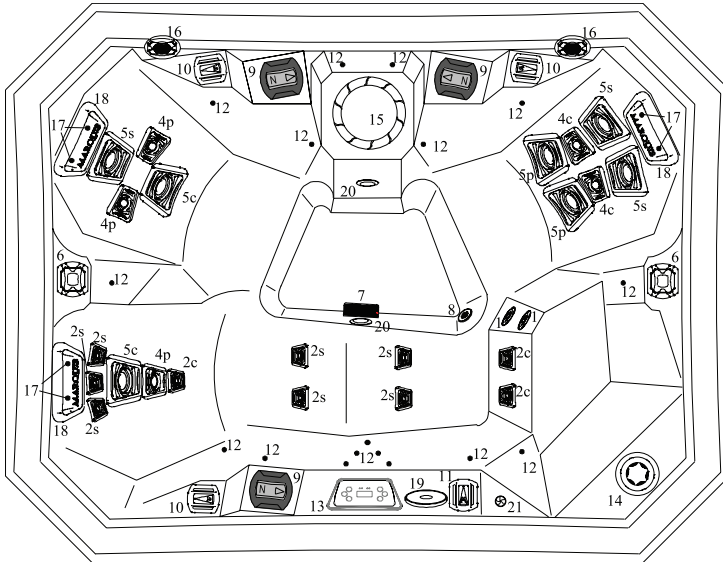

#	Component Identification	Qty.
1	Ozone fittings	2
2s	Directional Jetpod	7
2c	Conal Jetpod	3
4s	Directional Jetpod	0
4c	Conal Jetpod	2
4p	Orbital Jetpod	3
5s	Directional Jetpod	3
5c	Conal Jetpod	2
5p	Orbital Jetpod	2
6	Pop up water feature	2
7	Suction fitting	1
8	Floor drain	1
9	V ³ control valve	3
10	Air control valve	3
11	Waterfall valve	1
12	Starlights™ LED	17
13	Control panel	1
14	In-line Canister (option)	1
15	Vortex filter	1
16	Surface mount speakers (option)	2
17	Headrest buttons	6
18	Headrests	3
19	MicroSilk® control panel (option)	1
20	MicroSilk® return fittings (option)	2
21	MicroSilk® air intake fitting (option)	1
Physical Specifications		Size
Dimensions		65" x 84"
Height		29.5"
Seating capacity/positions		4/4
Weight dry lbs. / full lbs.		440/2191
Water capacity/gallons		210
Total therapy Jetpods		22

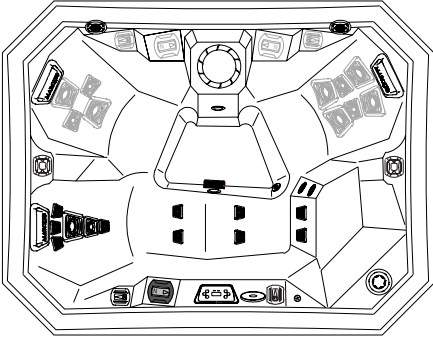

ZONE 1A

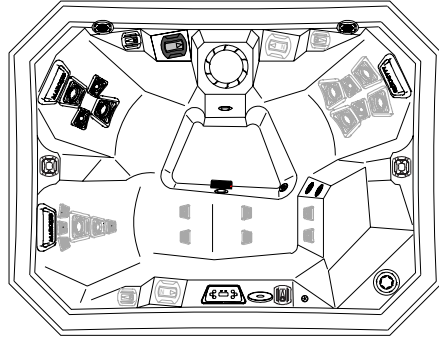

ZONE 1B

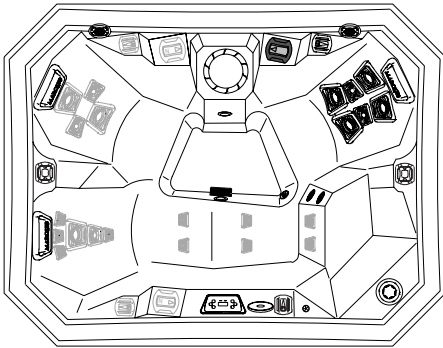

ZONE 1C

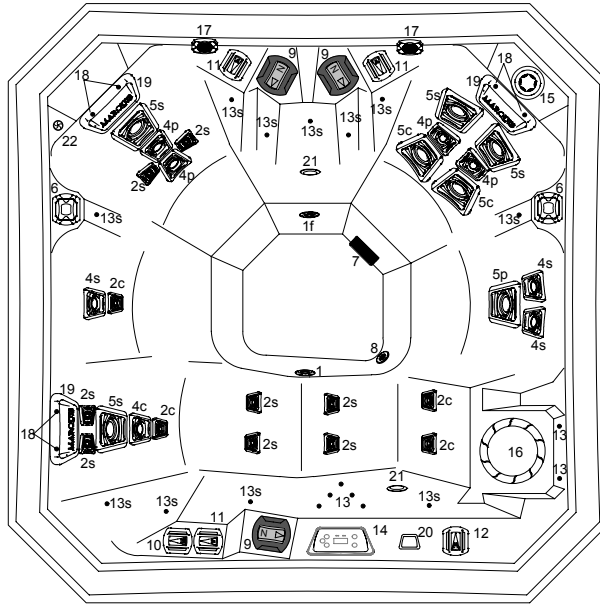

#	Component Identification	Qty.
1, 1f	Ozone fittings	1
2s	Directional Jetpod	8
2c	Conal Jetpod	4
4s	Directional Jetpod	3
4c	Conal Jetpod	1
4p	Orbital Jetpod	4
5s	Directional Jetpod	4
5c	Conal Jetpod	2
5p	Orbital Jetpod	1
6	Pop up water feature	2
7	Suction fittings	1
8	Floor drain	3
9	V ³ control valve	1
10	Neck Jet Valve	1
11	Air control valve	3
12	Waterfall valve	1
13	Starlights™ LED	11
14	Control panel	1
15	In-line Canister (option)	1
16	Vortex filter	1
17	Surface mount speakers (option)	2
18	Headrest buttons	6
19	Headrests	3
20	MicroSilk® control panel (option*)	1
21	MicroSilk® return fittings (option*)	2
22	MicroSilk® air intake fitting (option*)	1
Physical Specifications		Size
Dimensions		77" x 77"
Height		36"
Seating capacity/positions		6/6
Weight dry lbs. / full lbs.		550/2805
Water capacity/gallons		270
Total therapy Jetpods		27
*1 Pump V77L only		



THE V77L 1 PUMP ZONES

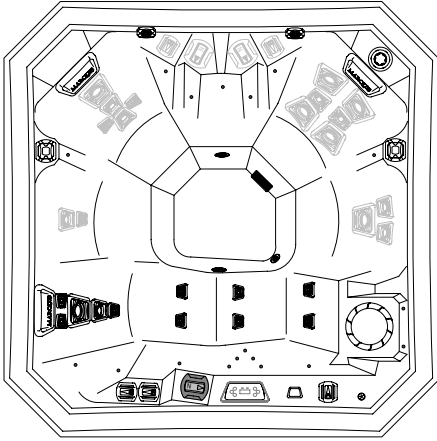

ZONE 1A

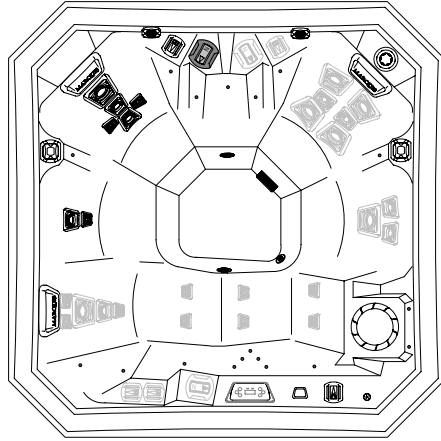

ZONE 1B

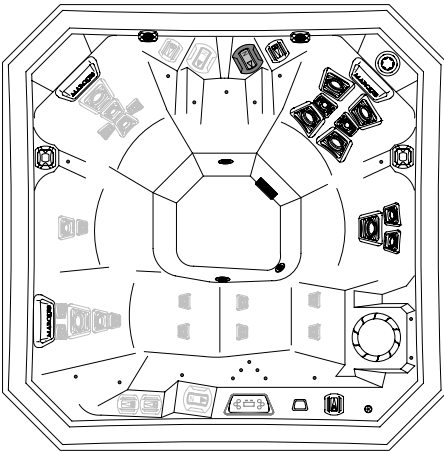

ZONE 1C

THE V77L 2 PUMP ZONES

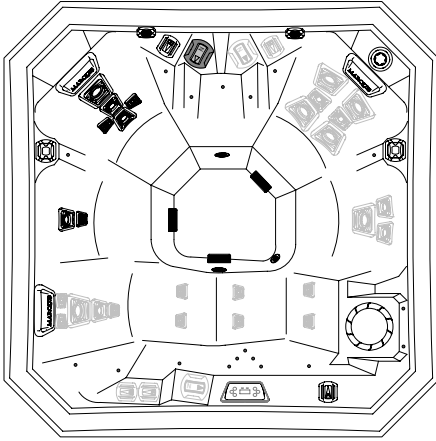

ZONE 1A

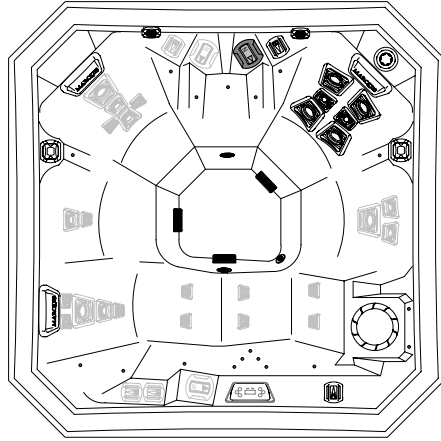

ZONE 1B

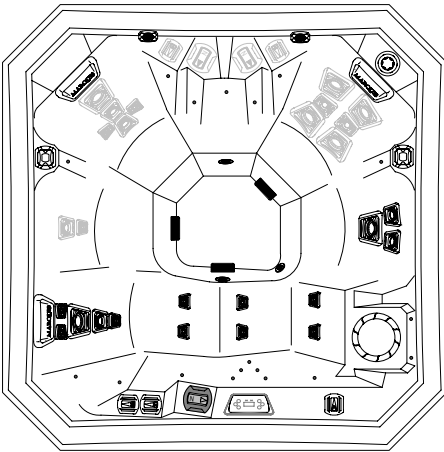

ZONE 2

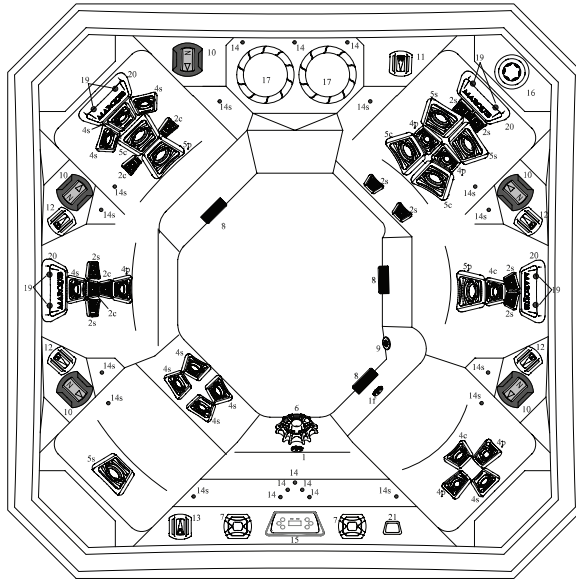

#	Component Identification	Qty.
1, 1f	Ozone fittings	1
2s	Directional Jetpod	8
2c	Conal Jetpod	4
4s	Directional Jetpod	9
4c	Conal Jetpod	2
4p	Orbital Jetpod	5
5s	Directional Jetpod	3
5c	Conal Jetpod	3
5p	Orbital Jetpod	2
6	Whitewater-4 Jet	1
7	Pop up water feature	2
8	Suction fittings	3
9	Floor drain	3
10	V ³ control valve	5
11	Neck Jet valve	1
12	Air control valve	4
13	Waterfall valve	1
14	Starlights™ LED	12
15	Control panel	1
16	In-line Canister (option)	1
17	Vortex filters	2
18	Surface mount speakers (option)	2
19	Headrest buttons	8
20	Headrests	4
21	MicroSilk® control panel (option)	1
22	MicroSilk® return fittings (option)	2
23	MicroSilk® air intake fitting (option)	1
Physical Specifications		Size
Dimensions		84" x 84"
Height		36"
Seating capacity/positions		6/6
Weight dry lbs. / full lbs.		700/3372
Water capacity/gallons		320
Total therapy Jetpods		37



THE V84 1 PUMP ZONES

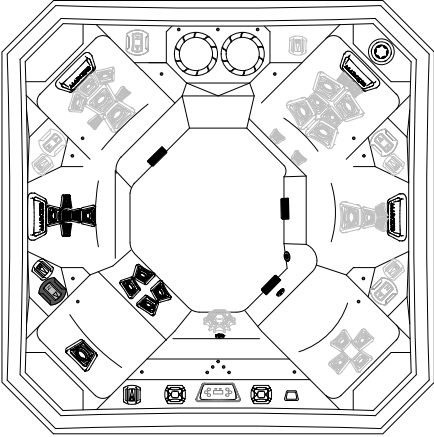

ZONE 1A

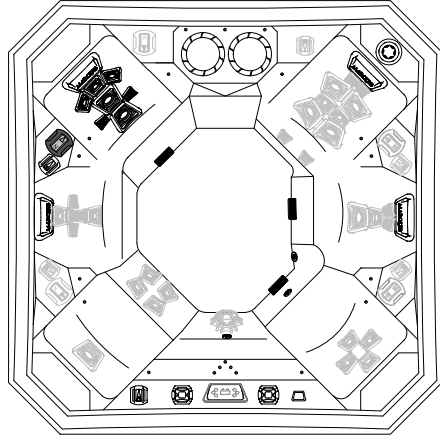

ZONE 1B

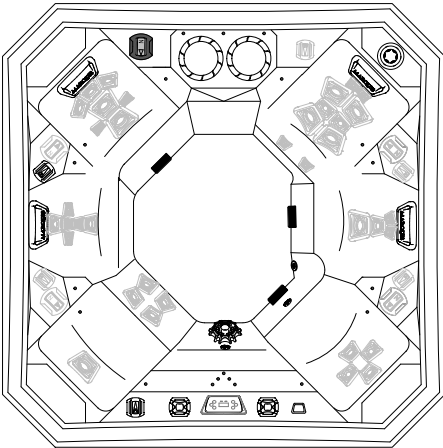

ZONE 1C



THE V84 2 PUMP ZONES

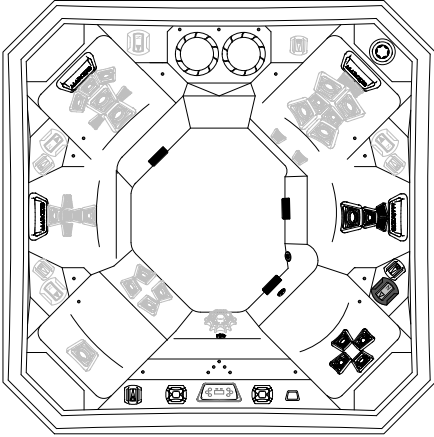

ZONE 2A

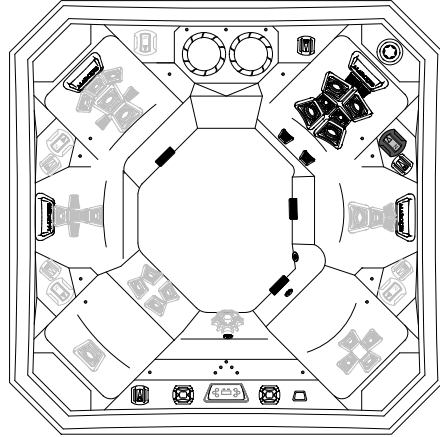

ZONE 2B

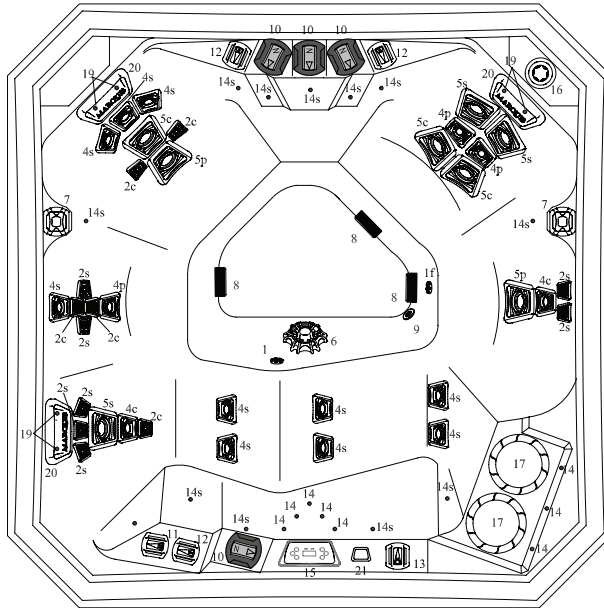

#	Component Identification	Qty.
1, 1f	Ozone fittings	1
2s	Directional Jetpod	7
2c	Conal Jetpod	5
4s	Directional Jetpod	10
4c	Conal Jetpod	2
4p	Orbital Jetpod	3
5s	Directional Jetpod	3
5c	Conal Jetpod	3
5p	Orbital Jetpod	2
6	Whitewater-4 Jet	1
7	Pop up water feature	2
8	Suction fittings	3
9	Floor drain	1
10	V ³ control valve	4
11	Neck Jet valve	1
12	Air control valve	3
13	Waterfall valve	1
14	Starlights™ LED	12
15	Control panel	1
16	In-line Canister (option)	1
17	Vortex filters	2
18	Surface mount speakers (option)	2
19	Headrest buttons	6
20	Headrests	3
21	MicroSilk® control panel (option)	1
22	MicroSilk® return fittings (option)	2
23	MicroSilk® air intake fitting (option)	1
Physical Specifications		Size
Dimensions		84" x 84"
Height		36"
Seating capacity/positions		6/6
Weight dry lbs. / full lbs.		700/3539
Water capacity/gallons		340
Total therapy Jetpods		36

THE V84L 1 PUMP ZONES

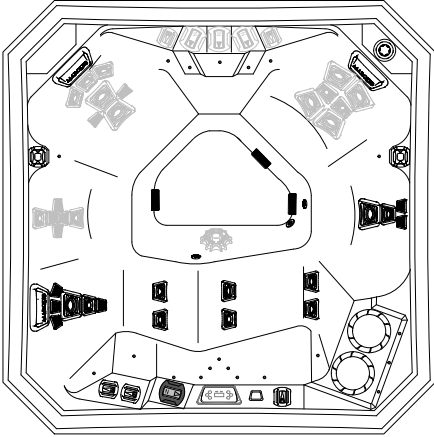

ZONE 1A

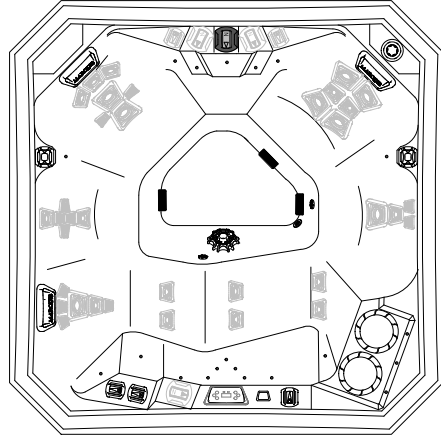

ZONE 1B

THE V84L 2 PUMP ZONES

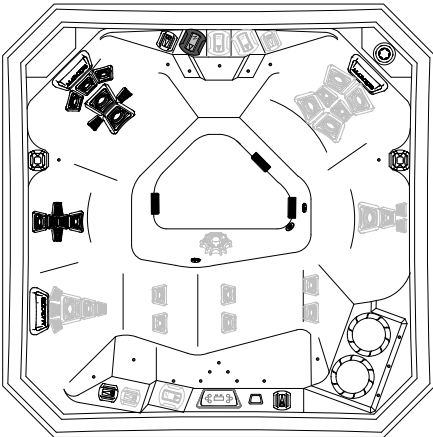

ZONE 2A

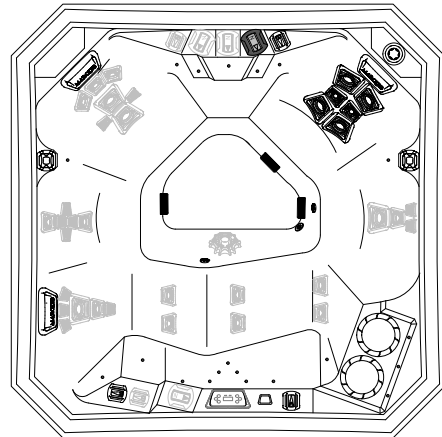

ZONE 2B

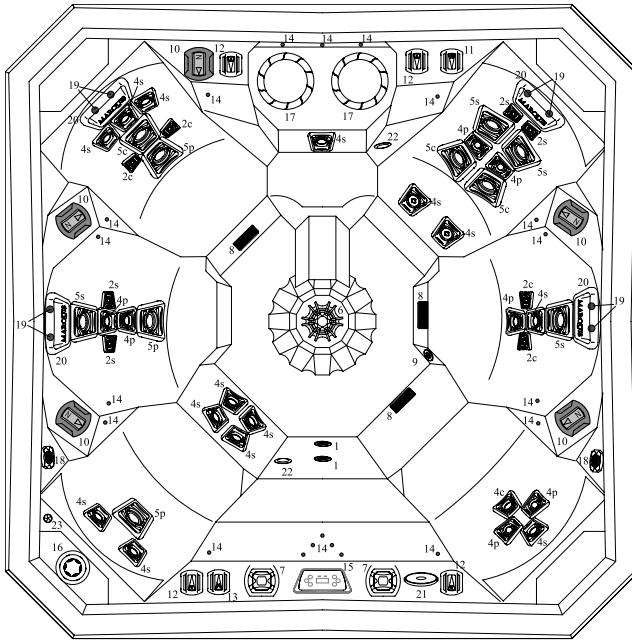

#	Component Identification	Qty.
1	Ozone fittings	2
2s	Directional Jetpod	4
2c	Conal Jetpod	4
4s	Directional Jetpod	14
4c	Conal Jetpod	1
4p	Orbital Jetpod	7
5s	Directional Jetpod	4
5c	Conal Jetpod	3
5p	Orbital Jetpod	3
6	Whitewater-4 jet	1
7	Pop up water feature	2
8	Suction fitting	3
9	Floor drain	1
10	V ³ control valve	5
11	Neck jet valve	1
12	Air control valve	4
13	Waterfall valve	1
14	Starlights™ LED	20
15	Control panel	1
16	In-line Canister (option)	1
17	Vortex filter	2
18	Surface mount speakers (option)	2
19	Headrest buttons	8
20	Headrests	4
21	MicroSilk® control panel (option)	1
22	MicroSilk® return fittings (option)	2
23	MicroSilk® air intake fitting (option)	1
Physical Specifications		Size
Dimensions		94" x 94"
Height		36"
Seating capacity/positions		8/8
Weight dry lbs. / full lbs.		840/4176
Water capacity/gallons		400
Total therapy Jetpods		41

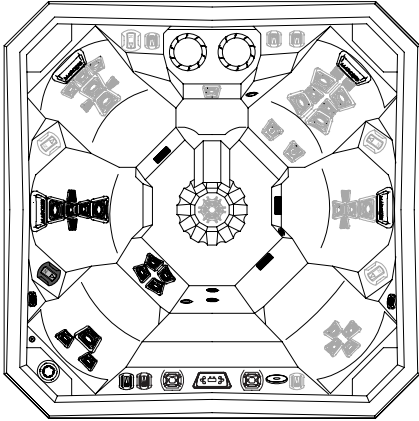

ZONE 1A

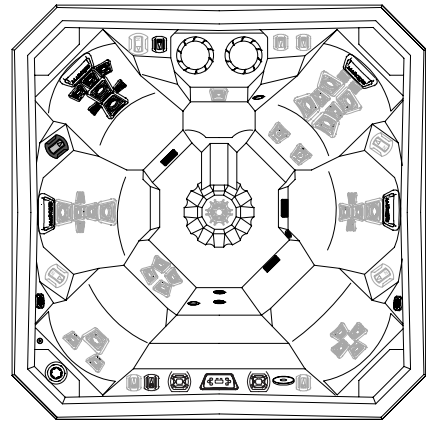

ZONE 1B

Waterfall runs off Pump 1

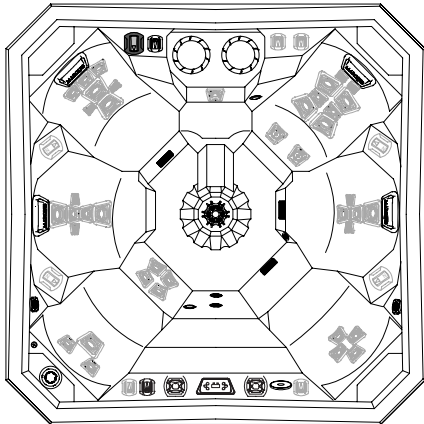

ZONE 1C

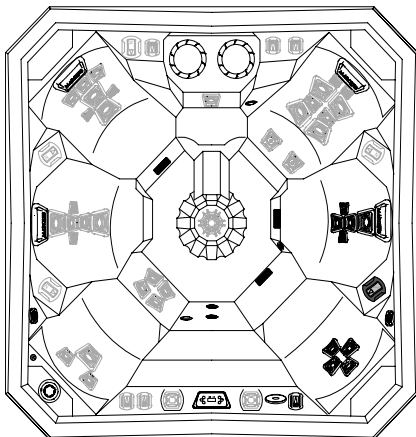

ZONE 2A

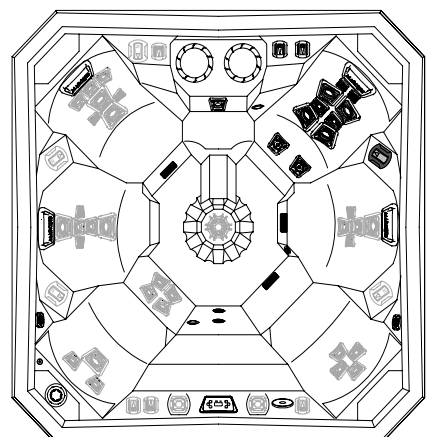

ZONE 2B

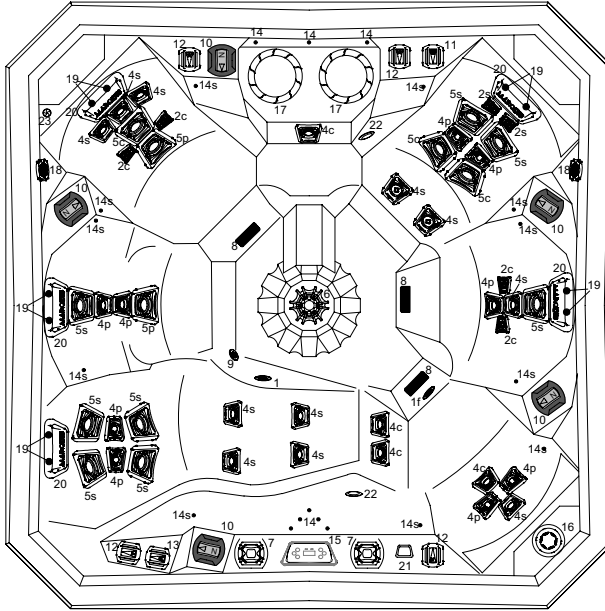

#	Component Identification	Qty.
1, 1f	Ozone fittings	1
2s	Directional Jetpod	2
2c	Conal Jetpod	4
4s	Directional Jetpod	11
4c	Conal Jetpod	4
4p	Orbital Jetpod	9
5s	Directional Jetpod	8
5c	Conal Jetpod	3
5p	Orbital Jetpod	2
6	Whitewater-4 jet	1
7	Pop up water feature	2
8	Suction fitting	3
9	Floor drain	1
10	V ³ control valve	5
11	Neck jet valve	1
12	Air control valve	4
13	Waterfall valve	1
14	Starlights™ LED	20
15	Control panel	1
16	In-line Canister (option)	1
17	Vortex filter	2
18	Surface mount speakers (option)	2
19	Headrest buttons	8
20	Headrests	4
21	MicroSilk® control panel (option)	1
22	MicroSilk® return fittings (option)	2
23	MicroSilk® air intake fitting (option)	1
Physical Specifications		Size
Dimensions		94" x 94"
Height		36"
Seating capacity/positions		6/7
Weight dry lbs. / full lbs.		840/4555
Water capacity/gallons		445
Total therapy Jetpods		44

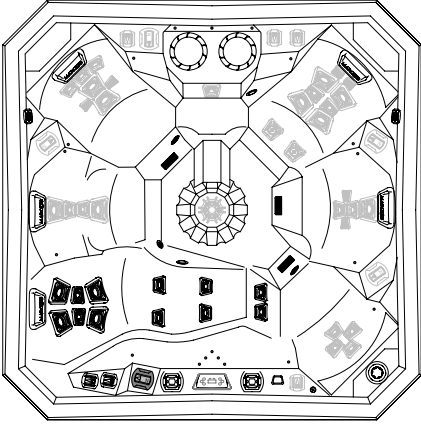

ZONE 1A

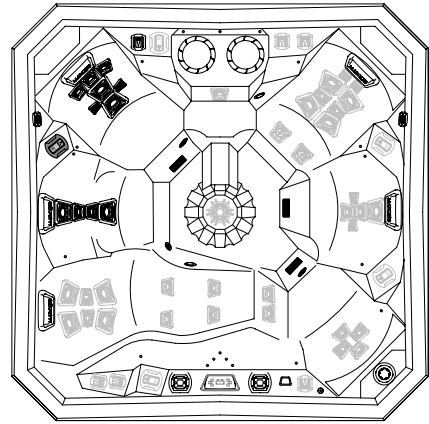

ZONE 1B

Waterfall runs off Pump 1

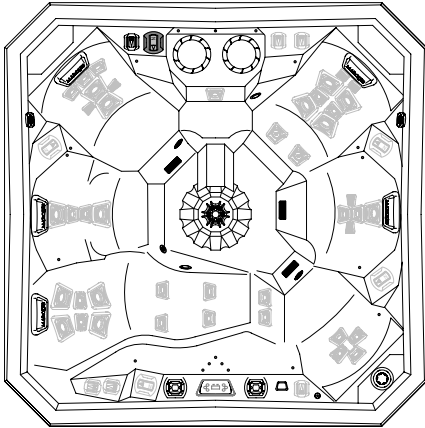

ZONE 1C

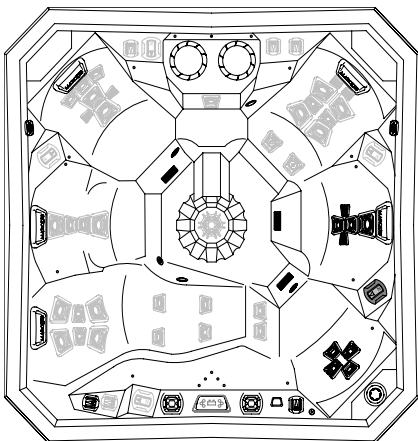

ZONE 2A

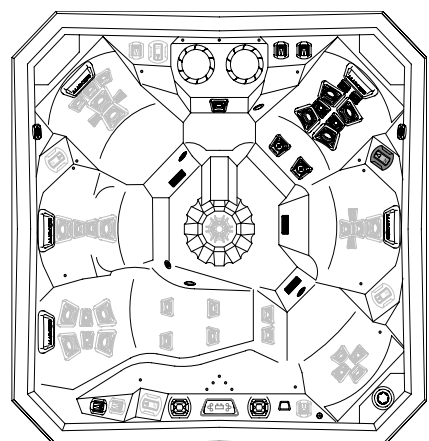

ZONE 2B

START-UP

FILLING THE HOT TUB

The water level should be filled to 2/3rds up the skimmer fins. Fill only with clean water. If your water source contains particles, please contact your dealer for a fill filter.

POWERING UP THE SPA

1. After the spa has been filled with water, power to the hot tub can be turned on. When power to the hot tub is turned on, the display on the control panel will read "RUN PMPS PURG AIR -- -- --". This is an opportunity to run the pumps and purge any air from the system and associated plumbing lines. This period will last 4-5 minutes or can be exited by pressing the Temp +/- button or pump buttons.
2. The hot tub controls are preprogrammed from the factory and will not require any additional modifications.

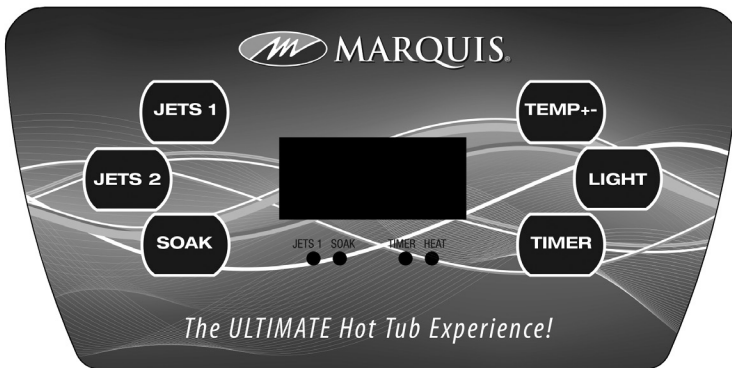

OPERATING THE ELECTRONIC CONTROLS

Jets 1

If the JETS 1 pump is off, press JETS 1 button to turn on pump 1 to low speed. Pressing a second time will turn the pump on to high speed. Pressing a third time will turn the pump off. The high speed of pump 1 will run for 15 minutes and then switch to low speed. Once on low speed the pump will run for 15 minutes and then shut off. To restart the pump, press the JETS 1 button." The orange LED indicator under the LCD display will illuminate anytime the pump is running.

NOTE: If the system is in a filter or heating cycle, low speed will continue to run.

Jets 2 (Two Pump Models Only)

Press the JETS 2 button to turn on pump two to low speed. Pressing a second time will turn the pump on to high speed. Pressing a third time will turn the pump off. The high speed of pump 2 will run for 15 minutes and then turn off. To restart the pump, press the JETS 2 button.

Adjusting temperature (factory default 100° F)

To adjust the temperature of the water, press the TEMP +/- button. The first press of the button will display the set temperature and begin to flash. Continue to press or hold the TEMP +/- to reach the desired set temperature. Once the display stops blinking the new temperature setting will be set. The factory default setting is 100° F (38° C). The minimum temperature that can be set is 60° F (16° C) and the maximum temperature that can be set is 104° F (40° C). The display always shows actual water temperature.

Soak

Pressing the SOAK button will turn off all pump operation. This is a useful feature when all you desire is a simple soak with no jet action. The Soak feature will last 60 minutes and then resume normal operation. Pressing any JETS button will override the soak feature and turn on the pumps or you can simply press the SOAK button to exit the mode. Turning the LED lights on and off will not affect the quiet soak mode. The orange LED indicator light under the LCD display will illuminate anytime this feature is engaged.

Note: If the system is heating it will take a few moments for the Quiet Soak feature to engage.

Timer

Press the TIMER button to start the timer. The display will start at E00 and begin timing how long you have been in the spa or using a certain feature. "E" is for elapsed and the two trailing characters track time in one minute intervals. The display will alternate with the current water temperature every 10 seconds. The timer will continue to run up to 60 minutes. To turn off, press the TIMER button one time. The orange LED indicator below the LCD display will illuminate anytime this feature is running.

Light

Press the LIGHT button to turn the interior spa lights on and off. If left on the lights will run for 60 minutes and then turn off automatically. If your spa is equipped with an LED light system, pressing the light button repeatedly (within 2-3 seconds of each press) will change the various colors of the LED lights.

Waterfall

Waterfall works on Pump 1. Press JETS 1 button and turn the Waterfall (W) valve.

USER PROGRAMMING

The following features allow for additional control and setting of the on-board electronics. In most cases the factory default settings are adequate for normal use and operation. To access any of the following features press TEMP +/- and then Light; then scroll through the features by continuing to press the LIGHT button. You exit the programming mode at any time by continuing to press the LIGHT button until you arrive back at the temperature display or by simply pausing for 30 seconds.



Filtration Cycles (Factory default is 1 hour or 2 hours, two times per day) Your filtration cycle may vary dependent on model and configuration. Your hot tub will begin the first of two filtration cycles 5 minutes after it has been powered up. The second filtration cycle will start 12 hours later. To change the time when the filtration cycles run, power down the spa for 1 minute and then turn the power back on at the point in time you want the spa to filter. For example, if you want the spa to filter at 3 PM and 3 AM, power the hot tub down at 2:55 PM or 2:55 AM. This will reset when the hot tub will run the filter cycles. In the event that the power to the hot tub is interrupted, you will need to repeat this procedure.

Programming how long the spa will filter

The electronic controls will allow you to change the length of time the hot tub will filter the water. This can be useful if your usage patterns vary from light to heavy and/or you need more or less filtration time to aid in maintaining water clarity. To adjust the filtration times, press the listed buttons in the following sequence. Button presses must occur within 30 seconds of each other.

To Program:

1. Press the TEMP +/- button followed by the light button to enter the programming mode to filter settings (FLTR).
2. Press the TEMP +/- button to make a change to the desired length of time. (each press changes the time in 1 hour increments).
3. Press the LIGHT button to set your selection and exit the filtration time option. If you do not do this the choice will not be saved.

Mode (Ready mode is factory default - recommended)

This feature can be used for periods when you will be gone for an extended amount of time and don't want the hot tub running on a continual basis. Running the unit in "Ready" mode will ensure the spa is at full temperature and ready for use at any time. Running the unit in "Rest" mode will only allow the spa to heat during a scheduled filtration cycle. To access and change the mode, press the listed buttons in the following sequence. Button presses must occur within 30 seconds of each other. Ready and Rest indicators are shown under the temperature in the display.

To Program:

1. Press the TEMP +/- button followed by the light button to enter the programming mode.
2. Press the LIGHT button again to enter the "mode" option.
3. Press the TEMP +/- button to toggle between "Ready" and "Rest" options.
4. Press the LIGHT button to set your selection and exit the filtration time option. If you do not do this the choice will not be saved.

COSMIC AUDIO SYSTEM (Optional)

Please refer to the manufacturer's owner's manual for features, operation, and troubleshooting.

This system will support a wide range of personal audio players with 3.5mm jacks operating at 4.5V or less. Typically this would be the headphone jack on the device.

Audio Expansion Port (Optional)

The built-in audio expansion port allows you to connect optional accessories. Use the supplied 3.5 mm cord to attach MP3 player. NOTE: The 3.5 mm auxiliary jack is designed for input only from devices such as an MP3 player operating at 4.5V or less.

NOTE: Avoid water splashing on the stereo face. Never operate the stereo with wet hands. Moisture can damage internal components. Water intrusion into stereo is not covered under warranty. See manufacturer's owner's manual for coverage information. Consult your Limited Warranty for more information about coverage.

CAUTION - Risk of Electric Shock. Replace components only with identical components.

Do not operate the audio controls while inside the spa.

WARNING – Prevent Electrocution. Do not connect any auxiliary components (for example, cable, additional speakers, headphones, additional audio/video components, etc.) to the system, except as provided by the following: The 3.5 mm auxiliary jack is designed for input only from devices such as an MP3 player operating at 4.5 V or less.

- These units are not provided with an outdoor antennae; it should be installed in accordance with Article 810 of the National Electrical Code, ANSI/NFPA 70.
- Do not service this product yourself as opening the unit may expose you to dangerous voltage or other risk of injury. Refer all servicing to qualified service personnel.
- If the power supply connections or power supply cord(s) are damaged; if water is entering any electrical equipment compartment area; or if there are signs of other potential damage to the unit, turn off the unit and refer servicing to a qualified service personnel.
- This unit should be subjected to periodic routine maintenance (i.e. once every three months) to make sure that the unit is operating properly.

MICROSILK® OPERATING INSTRUCTIONS (OPTIONAL)

- Press the “Start” button on the MicroSilk® panel that is located next to the master control panel to turn on the feature.
 - a. The pump will start and you will notice the presence of the micro-bubbles beginning to enter the water from two fittings in the footwell. Do not block these fittings during operation. Periodic bursts of air are normal and will not affect operation or effectiveness.
 - b. It can take up to 8 minutes depending on the size of model to completely fill the water with micro-bubbles. You will notice the water will change from clear to milky in appearance.
 - c. If any of the other therapy pumps are on, they will be turned off automatically after pressing the start button and may take up to 30 seconds for pumps to turn off. This is necessary for the proper concentration of micro bubbles to be generated. Once you start the MicroSilk® feature, you may run a pump on low speed, however it will reduce and diminish the effectiveness of the feature.
- The MicroSilk® pump will run for 20 minutes and then automatically turn off. If continued operation is desired, pressing the “Start” button will restart the system for another 20 minutes.
 - a. **Please note:** Periods longer than 20 minutes in elevated temperature may be harmful to your health. Please refer to the safety instructions in the Owner’s Manual.
- To manually turn the feature off, press the “Start” button on the MicroSilk® panel one time.
- A clean-up cycle will automatically turn on the filtration pump 30 minutes after using the feature.

Maintenance Considerations

- Due to the nature of how MicroSilk® works to exfoliate the skin, you may notice higher levels of body oils than normal. This can also be increased if multiple bathers are using the feature at the same time or more frequently. As a result, setting the controls to perform longer filtration or clean-up cycles may be necessary. Please refer to the instructions in the Owner’s Manual to make a change to the duration of the filtration or clean-up cycle.
- It is recommended to clean the filter cartridge/s once per month to ensure they are free from debris and oils. Failure to do so may result in poor water quality or the ability to properly clean up the water after use.
- It may be necessary to increase the setting on the bromine or chlorine cartridge located in the in-line sanitation housing or increase the amount of other sanitizer you may be using. Checking the sanitizer regularly and adjusting as needed is very important to water safety.

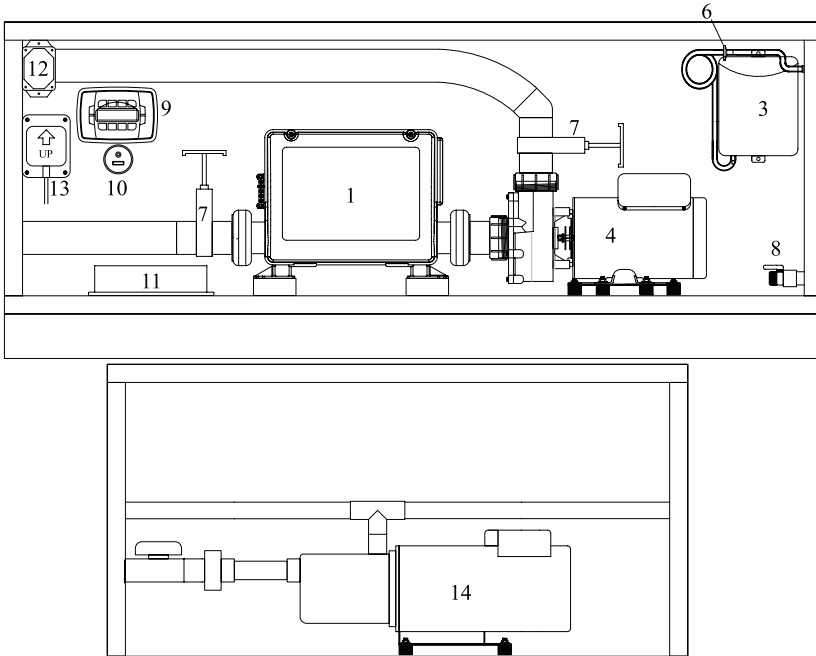
MODEL V65L

#	Component	Qty.
1	Control box and heater	1
3	Ozonator (optional)	1
4	2-speed pump	1
6	Check valve	1
7	Slice valve	2
8	Hose bib drain	1
9	Cosmic audio unit (optional)	1
10	Audio expansion port (optional)	1
11	Power supply (optional)	1
12	Starlights™ LED light system (optional)	1
13	Wi-Fi transceiver (optional)	1
14	MicroSilk® pump (optional)	1

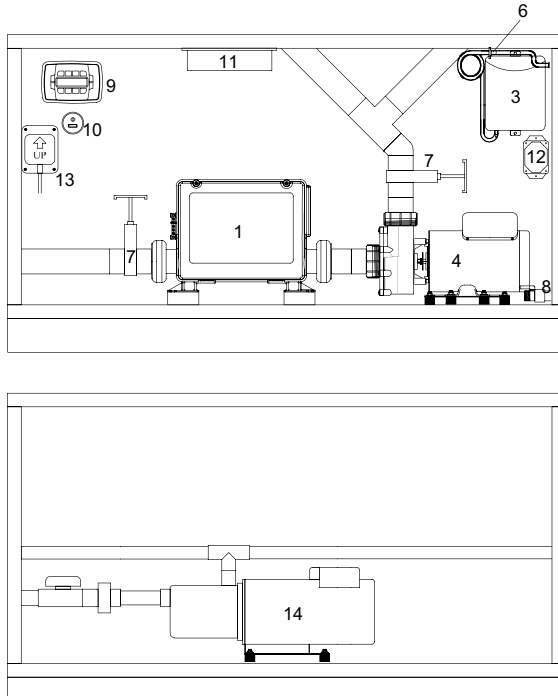
MODEL V77L 1 PUMP

#	Component	Qty.
1	Control box and heater	1
3	Ozonator (optional)	1
4	2-speed pump	1
6	Check valve	1
7	Slice valve	2
8	Hose bib drain	1
9	Cosmic audio unit (optional)	1
10	Audio expansion port (optional)	1
11	Power supply (optional)	1
12	Starlights™ LED light system (optional)	1
13	Wi-Fi transceiver (optional)	1
14	MicroSilk® pump (optional)	1

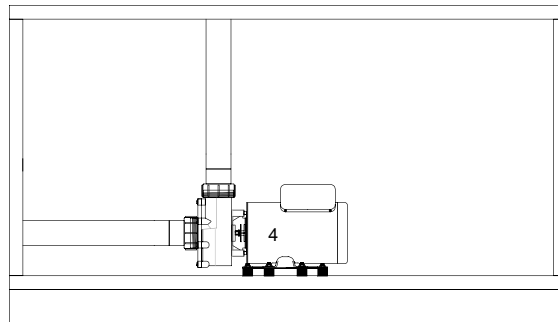
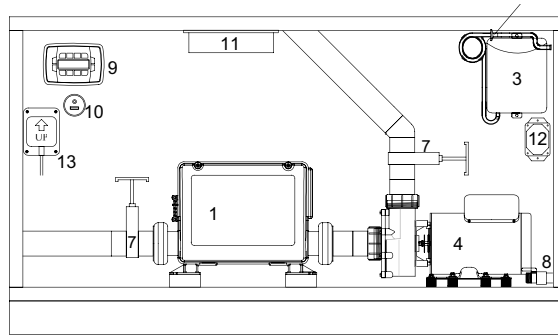
MODEL V77L 2 PUMP

#	Component	Qty.
1	Control box and heater	1
3	Ozonator (optional)	1
4	2-speed pump	2
6	Check valve	1
7	Slice valve	2
8	Hose bib drain	1
9	Cosmic audio unit (optional)	1
10	Audio expansion port (optional)	1
11	Power supply (optional)	1
12	Starlights™ LED light system (optional)	1
13	Wi-Fi transceiver (optional)	1

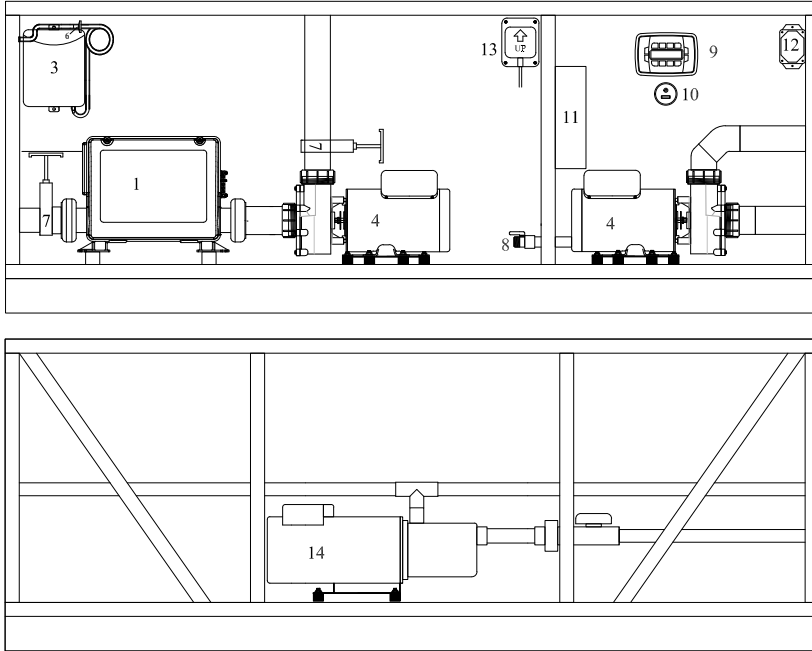
MODEL V84

#	Component	Qty.
1	Control box and heater	1
3	Ozonator (optional)	1
4	2-speed pump	2
6	Check valve	1
7	Slice valve	2
8	Hose bib drain	1
9	Cosmic audio unit (optional)	1
10	Audio expansion port (optional)	1
11	Power supply (optional)	1
12	Starlights™ LED light system (optional)	1
13	Wi-Fi transceiver (optional)	1
14	MicroSilk® pump (optional)	1

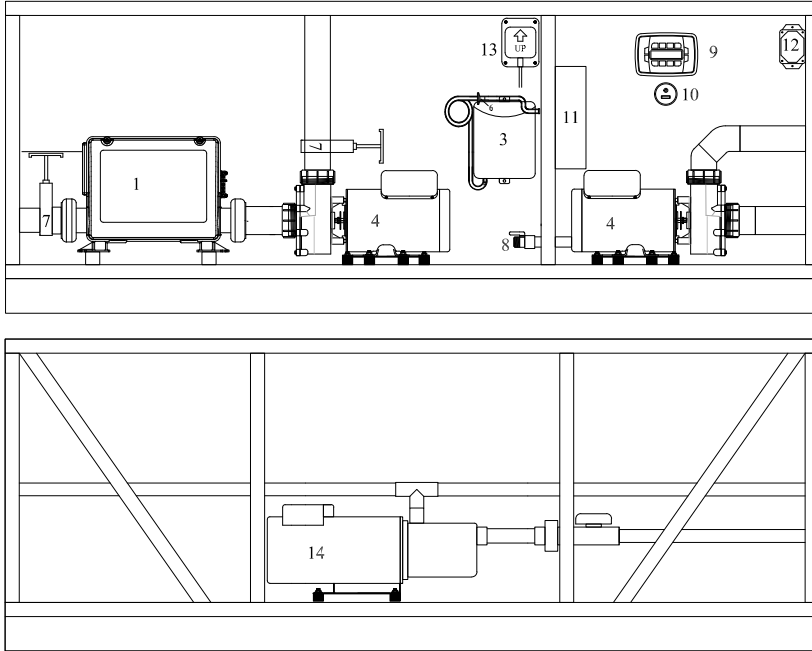
MODEL V84L

#	Component	Qty.
1	Control box and heater	1
3	Ozonator (optional)	1
4	2-speed pump	2
6	Check valve	1
7	Slice valve	2
8	Hose bib drain	1
9	Cosmic audio unit (optional)	1
10	Audio expansion port (optional)	1
11	Power supply (optional)	1
12	Starlights™ LED light system (optional)	1
13	Wi-Fi transceiver (optional)	1
14	MicroSilk® pump (optional)	1

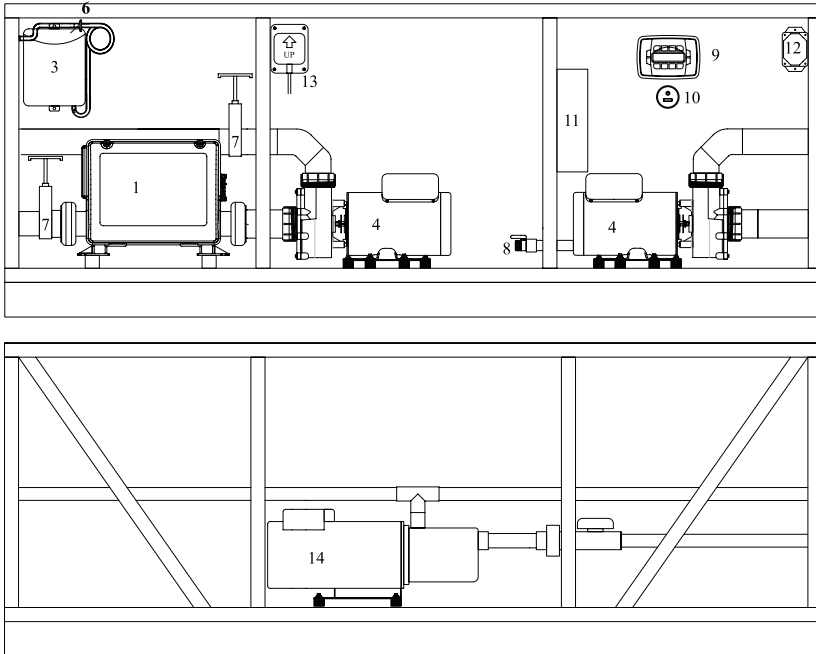
MODEL V94 & V94L

#	Component	Qty.
1	Control box and heater	1
3	Ozonator (optional)	1
4	2-speed pump	2
6	Check valve	1
7	Slice valve	2
8	Hose bib drain	1
9	Cosmic audio unit (optional)	1
10	Audio expansion port (optional)	1
11	Power supply (optional)	1
12	Starlights™ LED light system (optional)	1
13	Wi-Fi transceiver (optional)	1
14	MicroSilk® pump (optional)	1

PLEASE NOTE: The following corrective actions may be performed by the spa owner. If the trouble cannot be corrected in the steps below, please contact your authorized dealer for service. (Improper servicing by an unauthorized service provider or spa owner could result in damage not covered by the warranty and could cause serious injury.)

EQUIPMENT WILL NOT OPERATE

- Check the control panel LCD window for diagnostic code.
- 240V Spas: Check the circuit breaker on the main circuit panel.
- 120V Spas: Check the GFCI power cord and reset if necessary (see IMPORTANT SAFETY INSTRUCTIONS at beginning of manual).
- Check the condition of the power cord.

INADEQUATE JET ACTION

- Be sure the slice valves are completely open.
- Open the jets by turning the jet face to allow for maximum water flow.
- Check for obstruction or restrictions at suction guard(s) or filters, such as leaves, dirty filters, etc.
- Check to ensure water is at proper level and add water if needed.

NO HEAT

- Check temperature displayed in the LCD window for desired temperature setting.
- Inspect the filter cartridge for dirt and debris.
- Check that the water is at proper level, 2/3rds up the skimmer fins.
- Check to make sure spa is in "Heat Mode". See above for programming the temperature range.
- Lower ambient temperatures may result in heat loss.

NOTE: Do not expect instant hot water from the jets. It will take the heater 12-24 hours to heat the water to the temperature you desire.

LIGHT DOES NOT WORK

- Press the LIGHT pad on the control panel.
- Reposition the light bulb in the socket.

LCD DIAGNOSTIC MESSAGES

The advanced technology built into the spa allows it to perform a number of self-diagnostic system checks and it can display a variety of messages in the LCD window on the control panel.

TOO COLD: Freeze protection has been activated and no correction action is required. This normal on a fresh fill.

WATR TOO HOT: One of the sensors has reached 110°F (43°C) . Do not enter the water; contact your dealer for service.

HTR FLOW LOSS: There is not enough water flow through the heater. Clean or install new filter(s) and check that the slice valves or fully open. Call dealer for service.

HTR MAY BE DRY: There is little to no water flow through the heater. Check that the slice valves are fully open. Contact dealer for service.

HTR TOO HOT: One of the sensors has reached 118°F (48°C). Do not enter the water. Contact dealer for service.

PRES BTTN TO RSET: Some codes require a button press or power to be removed and restored.

SNSR BAL-- ANCE: The sensors are reading a temperature of 2°F (17°C) or more. This can occur on a fresh fill, no corrective action required. Contact dealer for service.

SNSR A: Sensor A is non-functional. Contact dealer for service.

SNSR B: Sensor B is non-functional. Contact dealer for service.

MEM FAIL: There is a problem with the firmware. Contact dealer for service.

MEM RSET: Memory has failed. Contact dealer for service.

CNFG FAIL: Contact dealer for service.

STUK PUMP: Water may be overheated (DO NOT ENTER THE WATER). Contact dealer for service.

HOT FALT: A pump may be stuck on. Contact dealer for service.

HOW TO PROLONG THE LIFE OF YOUR HOT TUB

There are some simple steps you can take to prolong the life of your hot tub. Please follow the guidelines listed below to ensure the most trouble-free and enjoyable use of your spa.

Rinse your feet

Please remember to rinse your feet before getting into the hot tub. This will help prevent sand and dirt from entering the plumbing system where it can clog valves and plug filters.

For beaches or coastal areas

If you are in an area prone to debris, such as fine sand or dirt, around or near the hot tub you may want to use a suction sock to help prevent debris from being drawn into the plumbing by the suction fittings. Suction socks are available from your Marquis Dealer.

Maintain your valves

If one of your valves begins to feel hard to turn, please remove the valve and rinse it. To remove the valve, please turn the power off to the spa and remove the handle for the valve. Remove the top cap off of the valve by pushing inward and lifting the decorative top off to expose the cap base and access the valve insert. Pull straight up on the insert, removing the valve stem. Clean and return the valve stem, then replace decorative top cap by pressing back into place. Slight scratches may be smoothed using fine grit sandpaper to remove scratches prior to re-installation.

Instructions for removing and changing Jetpods

To remove:

1. Using a thin #1 flat-head screwdriver, carefully place the head of the screwdriver in-between the top of the dark gray Jetpod face and the light gray Jetpod grill, off center to release the top tab.
2. The grill will now lift up and out, with two smaller tabs at either side. To reinstall:
3. Align the two small tabs on the side of the Jetpod grill above the side edges and slide the small tabs into both sides, steadying the grill in the center.
4. Once both side tabs are installed on either side, slide downward.
5. Press the top tab into the center of the top grill of the Jetpod. When you hear a click the Jetpod has been locked into place.

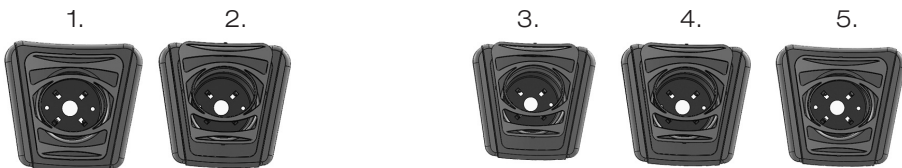

Keep the cover on

Always keep your hot tub cover closed when the spa is not in use. This helps prevent unwanted debris from entering the hot tub and prevents sun exposure that could damage the surface and the jets of the hot tub. For full warranty coverage, please note the spa must remain covered at all times when not in use.

Keep the water clear and balanced

Water chemistry is another important part of spa ownership. Please be sure to use only factory recommended products. In addition, please make sure you maintain proper pH and sanitizer levels. Drain and refill your hot tub with fresh water every 3 to 4 months. On a regular basis, please use a spa vacuum to remove dirt and sand that can be seen on the floor of the hot tub.

WEEKLY MAINTENANCE**Removing Debris**

Remove any debris and leaves from the Vortex skimmers and suction guard(s) on the inside of the spa. Blocked intakes can impede the flow of water through the jetting system.

Water Level

Replenish the water level if necessary so that it is approximately 2/3rds up the skimmer fins. (See STARTING YOUR SPA.) Low and high water levels can damage your spa. It is important to check your water level often.

MONTHLY MAINTENANCE**Filter Care**

We cannot stress enough the importance of a clean filter for proper water filtration. Also, please use an original Marquis® Vector21 filter cartridge to assure the best performance. Marquis® filters have been engineered with specifications for material and comply with manufacturer's requirements for flow and pressure. Using an inferior product may diminish the hot tub performance. Dirty filters can restrict water flow, cause cloudy water, and prevent your chemicals from working properly. Dirty filters may also cause low flow from jets, poor water clarity and sensors to activate error codes. It is important to clean filters regularly. Many water treatment products clear or clarify the water by coagulating microscopic particles and minerals together so that these larger particles may be effectively trapped in the filter. A filter clogged with debris and calcium deposits does not trap particles properly. Soak your filter cartridges in Marquis® *Rapid Action Filter Cleaner* monthly.

Removing the Filter

Unscrew the filter counter-clockwise and lift filter out.

Reinstalling the Filter

Screw the filter in clockwise while aligning the filter into the Vortex skimmer chamber.

CAUTION: Overtightening of the filter can cause the filter or filter housing to crack. Tighten filter until it is snug.

NOTE: Filters and filter lids do not qualify for labor coverage. These parts may be purchased or exchanged under warranty at your authorized Marquis® Dealer.

Leakage Detection

Open the equipment door and check for signs of water leakage around the pump(s). Pump seals wear out over time, especially with improper water chemistry. Early detection of pump seal failure can significantly reduce repair costs. Pump seals, heater gaskets and pump gaskets must be checked each month to ensure they are not leaking. Further damage caused by a leak from any component is not covered under the warranty.

EVERY THREE TO FOUR MONTHS

Draining and Filling the Spa

The average spa needs to be drained every three to four months. After months of continually adding chemicals to the water and introducing body oils and lotions, the water can be difficult to manage and chemicals are not as effective as usual. You may also notice excessive foaming. More frequent draining may be required dependent on use.

Draining the Spa

1. Turn off the power to the spa.
2. Open the equipment compartment (see EQUIPMENT DIAGRAM). Remove the hose bib cap from the connection and attach a hose.
3. Open the drain valve. Gravity causes the water to drain out of the hose.
4. When the spa is empty, close the drain valve and remove the hose. Reinstall the hose bib plug.

NOTE: Keep the drain valve closed at all times except when draining the spa (do not rely on the cap to stop the flow of water). Not doing so could result in damage to the drain valve due to freezing water.

Replacing the Mineral Cartridge

The *Spa Frog® mineral* or *@ease mineral cartridge* should be replaced every three to four months. You may still feel the “spent” minerals inside, but they are no longer effective and need to be replaced. (See ADJUST THE MINERAL CARTRIDGES, Blue Mineral Cartridge.)

Clean the DuraShell® Interior

Once the spa is drained, clean the DuraShell® interior thoroughly – especially at the water line. We suggest the *Glove Sponge* to clean without scratching.

Marquis® *Spa Brite or Gloss and Guard* are the recommended cleaning agent for DuraShell® – other products should be avoided except as stated below.

To maintain the high gloss and elegant look of DuraShell®, just follow these simple steps: For normal care and cleaning use a soft cloth or sponge and water. Rinse well and dry with a soft, clean cloth. Never use abrasive cleaners. Do not allow your acrylic surface to come into contact with products such as ketones or esters such as acetone or ethyl acetate (nail polish remover), Wintergreen oil (methyl salicylate), nail polish, dry cleaning solution or other chlorinated organic solvents, lacquer thinners, gasoline, aromatic solvents, citrus cleaners, pine oil, etc. Remove dust and dry dirt with a soft, damp cloth. Clean grease, oil, paint and ink stains with diluted isopropyl (rubbing) alcohol (do not let alcohol pool or remain on acrylic). Dry with a clean, soft cloth. Avoid using razor blades or other sharp instruments that might scratch the surface.

NOTE: Due to the high-gloss, fine finish of the acrylics, imperfections in the surface texture may occur. A natural aging process in acrylic can lead to a process called crazing. Fine spider web-like lines can form on the cosmetic surface of acrylic over time after exposure to the elements and chemicals.

Crazing represents no structural weakening of acrylic and is not covered under the warranty. Fading, staining and discoloration may also occur but represent no structural degradation and are not covered under warranty.

NOTE: Do not leave an empty spa uncovered. Direct sunlight on the spa surface can cause severe damage or blemishing, cause fittings to discolor and can result in the voiding of any surface warranties.

Refill the Spa

Fill the spa with fresh water from a garden hose and balance the water as described in the Water Treatment section. The use of a *Pre-Filter* is recommended when filling especially in areas of high mineral content in the water. Attach to the end of a garden hose to filter out any grit and sediment that could accumulate in the spa and potentially scratch the spa surface.

AS NEEDED MAINTENANCE

Cover Care

It is recommended that you use Marquis *Cover Cleaner* to keep the Dura-Cover® clean and conditioned. Proper care of the cover increases the life and keeps it looking great in even the harshest conditions. **NOTE:** Do not use regular household products or products that contain silicone, alcohol, steel wool, or bleach.

1. Remove the cover from the spa and gently lean it against a wall or fence.
2. Use a garden hose to spray the cover and loosen and rinse away dirt or debris.
3. Use a large sponge and/or soft bristle brush with a very mild soap solution. Scrub the vinyl top in a circular motion. Rinse vinyl clean before a soap film has a chance to dry.
4. Scrub the perimeter of the cover and side flaps. Rinse clean with water.
5. Rinse off underside of cover with water only (no soap) and wipe clean with a dry rag.
6. Use *Cover Cleaner* to condition the top of the cover after cleaning.

Cushioned Headrest Care

To increase the life of your cushioned headrest, remove and clean them with care only when necessary.

Remove Cushioned Headrest

Slip your fingers under each end of the interior cushioned headrest part and gently pull straight towards you. Damage caused to attachments due to improper removal is not covered under warranty. Pillows and attachments are warranted to be free of defects at delivery only.

DuraWood™ Care

Clean the exterior of the spa with a mild soap and water solution. Cleaners that contain alcohol or high levels of solvents, along with Acetone, Nitrobenzene, and Cyclohexanol, can dissolve and discolor the DuraWood exterior.

Excess Debris

Grit and debris tracked into the spa should be removed with a spa vacuum.

Water Line

To avoid buildup of oils and lotions at the water line, clean the interior weekly or when needed. We suggest the Glove Sponge to clean without scratching.

NOTE: Do not use the same brush or sponge to clean the exterior of the spa and the interior of the spa. Soap and other product residue used on the outside of the spa can cause foaming of the spa water and scratches to the spa surface if used on the inside of the spa.

SUSPENDED USE OR WINTERIZING THE SPA

If you decide to discontinue the use of your spa for any extended period of time, we suggest you follow the steps below.

NOTE: During long periods of inactivity, damage can occur to equipment from condensation within the equipment compartment. Failure to follow these instructions during freezing conditions will result in cracked fitting(s) and glue joints, and other damage.

1. Turn off the power to the spa.
2. Drain the spa. (See DRAINING AND REFILLING THE SPA.)
3. Remove all residual water from the seating and footwell. If necessary, bail out the remaining water, then dry the spa with towels. A wet/dry vacuum is recommended for best results.
4. When using the wet/dry vacuum, place vacuum nozzle over each jet nozzle to remove water from plumbing lines, starting with the highest jet and finishing with the lowest jet. **NOTE:** The spa is equipped with a zone control which is used to divert water between different jet zones. The valve must be "open" to the particular jets you are vacuuming.
5. Unscrew the pump plug(s) from the pump(s). (See STARTING YOUR SPA.)
6. Again, using the wet/dry vacuum, place nozzle over the exposed pump opening(s) to remove excess water. The pump(s) should be removed from the spa and stored in a climate-controlled room.
7. Clean the spa interior.
8. Clean the filter cartridges.
9. Reinstall the DuraCover[®] and lock in place. **NOTE:** Direct sunlight on the spa surface can cause severe damage or blemishing and can result in the voiding of any surface warranties.

VACATION CARE INSTRUCTIONS**Short time periods: 3-5 days**

1. Adjust the pH (see WATER CARE).
2. Sanitize the water by following the shock procedures (See WATER CARE).
3. Lock your spa cover in place with cover locks.
4. Upon return, shock-sanitize water, and test water before use.

Long time periods: 5-14 days

1. One day before leaving, set the temperature to its lowest level (approximately 80°F, 27°C).
2. Adjust pH as needed.
3. Shock-sanitize water.
4. Upon return, shock-sanitize water.
5. Return temperature to original setting.
6. Test water chemistry and adjust as necessary.

IMPORTANT CHEMICAL SAFETY PROCEDURES

1. Always keep chemicals out of reach of children.
2. Read product labels carefully prior to use.
3. When dissolving, always add chemicals to water, do not add water to chemicals. Some dry chemicals should be dissolved prior to adding them to the spa. Using a clean container, dip some water from the spa. Mix until dissolved, then add to circulating water.
4. **CAUTION:** Do not mix chemicals together. Add them separately to the spa water.
5. All chemical products should be stored in a cool, dry, well-ventilated area where the average temperature does not exceed 90°F (32°C). Keep storage area clean of debris such as rags, newspaper, and combustible materials.
6. Keep chemicals away from open flame or other heat source. Do not smoke near chemicals. If a dry chlorine chemical fire should occur, use water only. Do not use a dry chemical fire extinguisher to attempt to put out the fire.
7. When adding chemicals, always keep the water circulating in the spa with jets in a downward circular pattern for better chemical distribution. Add chemicals to the spa water one at a time. Allow several minutes between any new chemical additions using the jet action to evenly distribute throughout the spa.
8. It is important to leave the spa cover open for 20-30 minutes while shock treating your spa to avoid damage. Do not leave spa unattended while cover is open. Damage such as discoloration or brittle vinyl due to chemical damage is not covered under the warranty.
9. After adding chemicals, wait the amount of time recommended on the chemical container before retesting your water for an accurate reading. Retest your spa water before using.
10. If you have any questions or concerns about the correct procedures for handling chemicals, please contact your authorized Marquis® dealer.

CAUTION: Damage to the spa surface and equipment due to the use of trichlor chlorine, or other harsh chemicals not recommended by Marquis are not covered under warranty.

WATER CARE

There are three things necessary for clean safe water:

1. **CIRCULATE:** Water has to be circulated regularly; it can not be stagnant.
2. **FILTER:** Water has to be filtered to remove particulates and debris.
3. **SANITIZE:** Water has to be sanitized to kill organisms like algae, bacteria and virus.

It is critical to maintain proper water balance to protect the spa heater and other components from damage. Damage to the spa surface and equipment caused by poor chemical or harsh chemical treatment is not covered under the warranty. Discoloration of jet faces, valves and controls are an indication of poor chemical maintenance or exposure to the sun.

Jet inserts and valves do not qualify for labor coverage. These parts can be purchased or exchanged under warranty at your authorized Marquis® dealer. Gaskets and seals are not covered under the warranty. The control system in your Marquis spa will automatically circulate and filter. (See SPA CONTROL OPERATION, ConstantClean™ and SmartClean™ sections.) The sanitation requires minimal effort if done consistently and properly.

To sanitize spa water, four things are required:

1. BRING spa heat to set temperature point.
2. BALANCE: The water must be balanced so the sanitizer can work and spa equipment is protected.
3. SHOCK: Shock to oxidize organics and maximize sanitizer efficiency.
4. SANITIZE: Maintain a proper level of sanitizer at all times.

UNDERSTANDING WATER BALANCE

Water balance is the interrelation of factors that determine the quality of the spa water. The effectiveness of chemicals and other additives are dependent on all these factors working together or “in balance”. The primary elements to water balance are the calcium hardness, total alkalinity and pH. Always use water treatment products recommended for use in a Marquis spa.

pH Balance

Keeping the pH balanced is the most critical component of water balance. Calcium hardness and total alkalinity act as buffers to stabilize the pH. When they are properly adjusted, the pH will be stable and easy to maintain. The pH is a measure of the relative acidity and basicity of the water. The ideal pH range is 7.4 - 7.6. When the pH falls below 7.2, the water can become corrosive. Low pH can cause damage to metal in the control system and heater, excessive sanitizer consumption, and skin irritation. A pH above 7.8 can be scale-forming and allow metals or minerals in the water to form deposits and stain spa surfaces. pH above 7.8 can also cause eye and skin irritation.

Total Alkalinity

Alkalinity acts as a buffer to prevent the pH from changing as other substances are added to the water. Stability of the pH is directly related to the alkalinity. The alkalinity should be between 80 - 140 ppm. Alkalinity below 80 ppm makes it difficult to stabilize the pH. Alkalinity above 140 ppm may increase the pH and cause cloudy water, scaling, and decreased efficiency of the sanitizer.

Note: *Alkalinity Increaser* and *Alkalinity & pH Decreaser* will affect both the pH and alkalinity. Generally, smaller additions will change the pH and have a very minor effect on the alkalinity. Larger additions will also affect the pH, but will have a much greater effect on the alkalinity. (Example: If the pH is very high and the alkalinity is within range, adding a few smaller doses of *pH and Alkalinity Decrease* instead of one large dose will reduce the pH with little effect on the alkalinity.)

Calcium Hardness

Do not use soft water in your spa. It is critical to have calcium in your water. The ideal range of calcium is between 200 – 300 ppm. The calcium hardness is normally adjusted when filling or refilling after draining the spa. High calcium levels can cause scale buildup on spa surfaces and equipment. Your spa can be protected against high calcium by using *Metal & Stain Remover* per the directions on the container. Low calcium levels can cause spa water to become highly corrosive and damaging to the equipment components and plumbing. To raise calcium levels, use *Calcium Hardness Increaser*.

BALANCE

When initially filling or refilling your spa, follow these steps to achieve proper water balance.

IMPORTANT! Always follow instructions on the chemical container when adding chemicals.

1. Test the spa water using the appropriate test strip for your method of sanitation. If you are using the In-line system, each product has its own test strip for either a chlorine or bromine system.
2. If adjustments are needed for the pH and/or alkalinity, always balance the alkalinity before balancing the pH. The product(s) you should use to adjust pH and/ or alkalinity are *pH Increaser* or *Alkalinity Increaser* or *pH & Alkalinity Decreaser*. Make any additions per the directions on the bottle and then test and repeat if necessary until all readings are in the desired range.
3. Increase the calcium hardness if necessary.

SHOCK

Initial Treatment

Shock the spa using granular *Chlorine Sanitizer* or non-chlorine *Spa Shock*. Add directly to the spa per the instructions on the container. For the initial treatment, *Chlorine Sanitizer* is preferred as it will also establish a residual of sanitizer. For shocking after initial startup, you may use non-chlorine shock.

Maintenance Treatment

Once bacteria and other wastes are neutralized by the sanitizer, they stay in the water unless oxidized or shocked. Often called chloramines or bromamines, they create dull, cloudy water and can cause odor and eye or skin irritation. Shock treatment rids your spa of these wastes for clear, sparkling water. Shocking with non-chlorine *Spa Shock* or granular *Chlorine Sanitizer* is recommended once a week or whenever the water appears dull or cloudy or has a strong odor. Non-chlorine *Spa Shock* allows use of the spa 15 minutes after shock treatment.

NOTE: A strong bromine or chlorine odor typically indicates the spa needs to be shocked – not that there is too much bromine or chlorine in the water. A properly balanced spa that is shocked regularly will not have an odor.

SANITIZE

ConstantClean™ System

The ConstantClean™ system utilizes a combination of sanitizers to increase water quality and significantly decrease maintenance. The combination of a *Spa Frog® Cartridge system* or *@ease Chlorine system** and the factory installed ozonator greatly reduce the amount of sanitizer required. Instead of the normal 3 - 5 ppm of bromine or chlorine, you may only need to maintain 1 - 2 ppm of bromine or chlorine at .5 - 1 ppm.

NOTE: The use of *Spa Frog® floating cartridges* or *@ease Smartchlor* is recommended. Do not use other floating chemical dispensers or Biguanide. Damage to the spa shell and other internal components can occur.

* The built-in sanitation system is not available in some international markets. However, the ozone system is available on all spa models in all countries. Please see your dealer for recommended alternate treatment method if the built-in sanitation system is not available.

BUILT-IN SANITATION SYSTEM*

After the spa has been brought to set temperature and the balance has been established, Shock-sanitize the spa. Then it is time to install the *Spa Frog®* or *@ease with SmartChlor Chlorine* and mineral cartridges.

ADJUST THE MINERAL CARTRIDGE

Remove the protective cellophane wrap from the blue *Spa Frog®* or *@ease mineral cartridge*. While holding the bottom of the cartridge, turn the top until the number six appears in the setting window. Install into the holder

NOTE: The mineral cartridge should be replaced every three to four months. You will still feel the “spent” minerals inside, but they are no longer effective and the cartridge needs to be replaced. It is recommended to drain and refill the spa at the same time you replace the mineral cartridge.

ADJUST THE SANITIZING CARTRIDGE

Remove the protective cellophane wrap from the *Spa Frog® bromine cartridge* or *@ease Chlorine cartridge*. Finding the right setting for the sanitizing cartridge will require monitoring your usage for the first few weeks. Begin with an initial setting based on the chart below and monitor sanitizer levels daily for the first week or so, adjusting the cartridge by one setting per day until a .5 - 2 ppm level has been achieved depending on whether you are using bromine or chlorine. To adjust cartridge, remove from system and turn to the next highest setting if the bromine level is low or the next lower setting if the sanitizer level is high. The sanitizing cartridge needs to be replaced when empty between two and four weeks. Install the cartridge only after the spa has been balanced, brought to temperature and sanitized.

Suggested *Initial* Sanitizer Cartridge Settings

Daily filter time	Spa Gallons			
	-250	250-300	300-400	400-500
One hour	2	2	3	4
Two hours	2	2	2	3
Four hours	1	1	2	2



INSTALL THE CARTRIDGES

Locate and remove the cartridge holder cap on the top lip of the spa. Push down and turn the holder counterclockwise to unlock. Lift holder out. Snap the *mineral cartridge* into the area of the holder marked "MINERALS" (top portion), making sure to line up the indentation near the top of the cartridge with the raised line on the holder. Then snap the *Spa Frog® sanitizing cartridge* or *@ease with SmartChlor* into the area of the holder marked "BROMINE or CHLORINE". Be sure to line up the indentation on the cartridge with the raised line on the holder. After cartridges are snapped in, return the holder, push down, and then turn clockwise to lock into place. Replace the cap.

CAUTION: Hand-tighten only; avoid over tightening; avoid bending the holder to help prevent damage to the holder. Damage caused due to improper removal or installation of chemical cartridge holder is not covered under the warranty. Cartridge holder is warranted to be free from defects at time of delivery of spa. Chemical cartridge holders do not qualify for labor coverage. These parts can be purchased or exchanged under warranty at your authorized Marquis® dealer.

REMOVE THE CARTRIDGES

Reverse above procedures to remove cartridges.

*The built-in sanitation system is not available in some international markets. See your authorized Marquis® dealer for recommended alternate water treatment method.

WATER CARE REGIMEN

Marquis SpaCare™ products are classified by easy to follow usage guidelines. The information below indicates whether the product should be used daily, weekly, monthly, when filling, or as needed – if special water conditions arise.

DAILY

Sanitizer – You must keep a residual of preferred sanitizer in the hot tub. Maintain 1 - 2 ppm of bromine or .5 - 1 ppm of Smartchlor chlorine at all times.

WEEKLY

Spa Shock

Sanitizer combines with bacteria and neutralizes sanitizer/bacteria on contact. However, the used sanitizer/bacteria particle is still present in the spa water. Used sanitizer in the water emits an odor and causes cloudy water. To oxidize, or rid the spa of this used sanitizer, you must shock the spa once a week for bromine or once a month for @ease with Smartchlor. For best results, and to protect your spa cover leave the spa cover open for a minimum of 20 minutes after shocking the water.

NOTE: Additional shocking may be necessary if the spa is under heavy use.



AS NEEDED PRODUCTS

pH Increaser and Alkalinity Increaser

pH & Alkalinity Decreaser

These two products work to raise or lower the pH and alkalinity in the spa. They are only needed if the test strip indicates the levels are not in the ideal ranges. It is imperative to balance water for clean, clear water.

Water Clarifier

Microscopic particles can pass through the spa filter and create cloudy water. The use of *Marquis® SpaCare™ Water Clarifier* combines these microscopic particles into larger particles that can be trapped in the filter to clear cloudy water.

Spa Defoamer

If foam appears in your spa, the action of the jets will keep it from dissipating. The use of *Marquis SpaCare™ Defoamer* instantly rids your spa water of foam.

Metal and Stain Remover

Marquis® Metal and Stain Remover will remove metals such as iron and copper from spa water.



WATER CARE TROUBLESHOOTING GUIDE

NOTE: If you request a service call and no problem is found with the spa or the problem is not covered by warranty (i.e. chemical damage), you will be charged at the regular service rate.

- P: Problem
- S: Solution

Cloudy Water

- P: Inadequate filtration or dirty filter.
- S: Ensure that the filter is securely installed. Clean or replace filter. Increase the length of clean up and/or filter cycles.

- P: Water is not balanced.
- S: Test water and adjust pH, alkalinity, and sanitizer as needed. Shock to oxidize and destroy organics in the water.

- P: Unfiltered particles or chemically saturated.
- S: Use *Water Clarifier* to combine particles.

- P: High total dissolved solids
- S: Drain, clean, and refill the spa.

Chemical Odor

- P: Too many chloramines/bromamines in the water.
- S: Treat water with *Spa Shock*, then adjust sanitizer level as necessary.

- P: Dull looking water, difficult to manage. High total dissolved solids (TDS) may be the cause.
- S: Drain, clean and refill with fresh water.

Musty Odor

- P: Not enough sanitizer in water – bacteria or algae in water.
- S: Add sanitizer as necessary and shock. Readjust sanitizer level if necessary.

Yellow Water

- P: Low pH and/or low alkalinity.
- S: Test and adjust pH with *pH and Alkalinity Increase*. Adjust alkalinity if necessary.

Foaming

- P: High concentration of body oils, lotions or soaps, as well as excessive organics.
- S: Use *Spa Defoamer* and adjust pH and sanitizer as needed.

Scum Line in Spa

- P: Body oils and dirt.
- S: Use *Glove Sponge* to clean the spa. Test and adjust the sanitizer and pH if necessary. Increase the clean up cycle.



No Sanitizer Reading

- P: Sanitizer level is too low.
- S: Shock and/or adjust *sanitizing cartridge* until the sanitizer registers in the recommended range.

- P: Test strip remains “white” even after sanitizer has been added.
- S: Sanitizer level could be extremely high. It can bleach the reagents on the test strip and give a false reading. Remove spa cover and activate jets and air control. Allow jets to run for 30 minutes. Test water to see if desired level has been reached. Adjust *sanitizing cartridge* to reduce sanitizer level.

High Sanitizer Reading

- P: Too much chlorine or bromine added or dispensed into the spa.
- S: Remove spa cover and activate jets and air control. Allow jets to run for 30 minutes. Test water to see if desired level has been reached. Adjust *sanitizing cartridge* to reduce sanitizer level.

Eye or Skin Irritation

- P: Contaminants or excessive amount of chloramines/bromamines in water.
- S: Treat water with *Spa Shock*. Adjust sanitizer level.

- P: pH is low.
- S: Adjust as needed.

Corrosion of Metal

- P: Low pH.
- S: Adjust pH with *pH and Alkalinity Increase*.

Green Water/Algae

- P: Low sanitizer level or high pH.
- S: Adjust pH, shock and/or adjust *sanitizing cartridge* as necessary.

Erratic pH

- P: Alkalinity and/or calcium hardness are too low causing pH “bounce”.
- S: Test and adjust alkalinity and/or calcium hardness to bring them into the ideal range.

STEP INSTALLATION (OPTION)

The step and mounting brackets may be placed along a straight side of the spa, most often centered to the entry location.

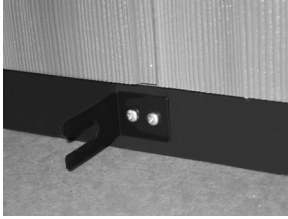

1



2

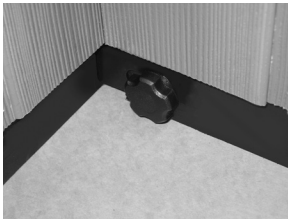

3

Find the center of the spa side where you want to mount the step. Measure 27.5" (699mm) center spread and mark. Measure 1" (25mm) up from base and mark (see diagram).

- With step mounting brackets facing outwards mark the two holes.
- Using the bracket as a guide, predrill two holes per bracket.
- Attach the left and right brackets to the spa exterior base (#1).
- The step hardware is factory-installed. Loosen the thumbscrew. Gently push step towards the spa until the brackets and hardware engage (#2).
- Tighten the thumbscrew to attach the step to the spa exterior (#3).

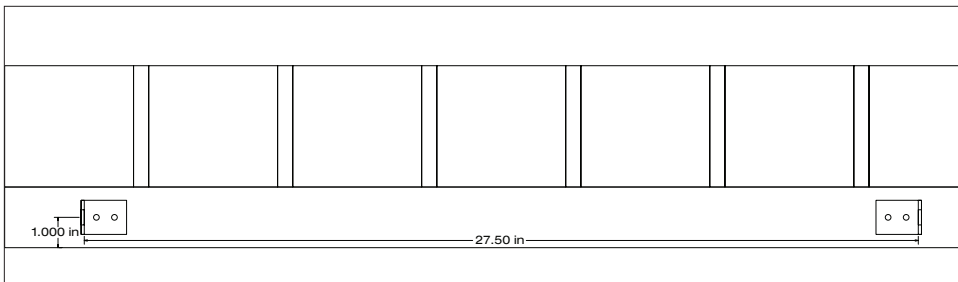

All steps can be inherently dangerous. Always use caution in stepping in and out of your spa.

VECTOR21 HOT TUBS: V65L, V77L, V94 & V94L**WHAT THE MARQUIS CORP. LIMITED WARRANTY COVERS**

Marquis Corp. warrants that our products will be free from defects in materials and workmanship for the term set forth exclusively in this warranty. Accessories purchased from Marquis Corp. or a Marquis Corp. authorized dealer and added to the spa after manufacture of the spa are not covered under this warranty but may have other warranties. Refer to owner's manual for proper use, maintenance and installation of your spa. The Limited Warranty is made only to the original purchaser of the spa and is not transferable.

- [5] STRUCTURE:** The fiber glass structure is warranted for five years not to leak. Fittings and attachments are not included.
- [2] SURFACE:** The acrylic surface is warranted for two years against blisters, cracks and delamination. Use of a non-Marquis® DuraCover® will void this coverage.
- [3] PLUMBING:** Plumbing and fittings are warranted against water loss for three years. Warranty coverage does not include gaskets or seals.
- [3] EQUIPMENT:** Electronic equipment is warranted against defects in materials and workmanship for three years. Equipment includes equipment packs, PC boards, pumps, control panels, heater and heat sensors. MicroSilk® system and associated components have a one year parts and labor warranty.
- [1] EXTERIOR:** The synthetic skirt exterior is warranted against cracking and peeling for one year.
- [1] COMPONENTS:** The ozonator and GFCI are warranted against defects in material and workmanship for one year.
- [1] PARTS:** LED lights, remote controls, valves, spa cover, stereo components, jet inserts and overlays are warranted for one year. These parts do not qualify for labor coverage under this warranty. Fuses, non-LED lights, filter, filter lid, cushioned headrests and other items not specifically mentioned in this warranty are warranted to be free from defects in materials and workmanship at time of delivery. These parts do not qualify for labor coverage under this warranty.

TERM OF THE MARQUIS CORP. LIMITED WARRANTY

The term of your warranty begins on the date the product is sold to you and continues for the term described in this warranty for each component.

WHAT YOU SHOULD DO IF YOU EXPERIENCE A PROBLEM

Unless otherwise designated in writing by Marquis Corp., Marquis Corp. or its agent are the only parties authorized to perform warranty service on Marquis Corp. spas. Upon experiencing a problem, please contact your authorized dealer. You will be asked to provide the following information when requesting warranty service: your name, address and contact information; serial number; a description of your spa and a description of the problem. You will be required to provide proof of purchase of your spa prior to receiving warranty service.

WHAT MARQUIS CORP. WILL DO IN THE EVENT OF A PROBLEM

Marquis Corp. agrees to repair any plumbing or surface defects and to repair or furnish a replacement for any factory-installed component covered under this warranty which, upon test and examination by Marquis Corp., proves to have manufacturing defects. All materials for examination must be returned to Marquis Corp. freight prepaid.

Marquis Corp. will provide parts and labor where applicable (according to predetermined schedule) at no charge to repair or replace components that fail due to manufacturing defects. Responding authorized dealer may charge additional service and travel fees.

In the event that Marquis Corp. or its agent determines that your problem can be addressed by providing a replacement part to you for installation in your spa, a replacement part will be provided to you at no charge when you return the defective part. All replacement parts assume the original warranty status of the spa into which they are installed, including time remaining on warranty, and have no separate or independent warranty of any kind.

To facilitate repairs, Marquis Corp. or its agent may require access to spa equipment. It is your responsibility to provide unencumbered access.

WHAT THE MARQUIS CORP. LIMITED WARRANTY DOES NOT COVER

No warranty will apply to any spa that has been (i) modified, altered or adapted without Marquis Corp.'s written consent; (ii) maltreated or used in a manner other than in accordance with the spa owner's manual; (iii) repaired by any third party not authorized by Marquis Corp.; (iv) improperly installed by any party; (v) used with equipment not covered by this warranty, to the extent that problems are attributable to such use; (vi) relocated to the extent that problems are attributable to the relocation; (vii) located on any support surface other than specified in the spa printed instructions; and (viii) damage caused by pH level outside the range of 7.4 to 7.6 and other chemical abuse. Refer to instructions in the owner's manual for proper use, maintenance and installation of your spa.

Other items not included in this warranty are freight expenses; labor and material cost associated with removal and or replacement of the spa; damage to or fading of the spa surface and staining of the spa surface or equipment caused by impact, scratching, abrasive or corrosive cleaners; damage due to extreme water temperatures outside the range of 32°F to 120°F (0°C to 49°C) even if the damage was the result of a covered failure; or damage to the spa surface or equipment caused by acts of nature, including wind and power surges. Damage to the spa surface and equipment due to the use of trichlor chlorine, or other harsh chemicals not recommended by Marquis is not covered under warranty. Damage to the spa surface and fittings caused by leaving the spa uncovered and empty of water with direct exposure to sunlight may cause solar heat distress and also invalidates this warranty.

Other costs not associated with the direct repair of the spa, such as phone charges and missed work are not included in this warranty. In the event that the Marquis Corp. serial number tag on the spa has been removed or tampered with, the warranty will be void. Customer may not dismantle spas, and any attempt to dismantle systems, other than described herein, constitutes a modification or alteration of the spa which voids the applicable warranty.

LIMITATIONS

Your sole and exclusive remedy and Marquis Corp.'s entire liability in connection with manufacture and sales of its spa products is repair or replacement (at Marquis' option) of a defective part, as expressed in the limited warranty. Any other express or implied representation or warranty, including the implied warranties of merchantability and of fitness for a particular purpose as well as non-infringement, is excluded to the maximum extent permitted by law.

Except as may be required by applicable law, Marquis Corp. shall not be liable for injury, loss, or damage to person or property, however arising, in connection with manufacture or sale of its spa products. This includes indirect, punitive, special, incidental, or consequential damages (including but not limited to loss of use) whether the claim for such injury, loss, or damage is based on breach of contract, breach of warranty, or tort, even if Marquis Corp. has previously been advised of the possibility of such damages.

This limited warranty gives you specific legal rights, and you may also have other rights which vary from state to state.

VECTOR21 STEREO SYSTEM LIMITED WARRANTY**STEREO SYSTEM ONE YEAR LIMITED WARRANTY**

Marquis Corp. warrants to the original retail purchaser, the components of the stereo system will be free from defects in material and workmanship for a period of one year from date of purchase. One year coverage includes parts and labor. Optional remote not included in this warranty: other warranties may apply from the original manufacturer of the optional remote. The stereo system Limited Warranty is made only to the original purchaser of the spa and is not transferable.

In no event shall any obligation of Marquis Corp. extend beyond the original period of any applicable warranty determined according to the effective warranty date of the original purchaser.

PERFORMANCE OF WARRANTY

Marquis Corp. agrees to repair or furnish a replacement for any defects in stereo system material or workmanship which upon test and examination by Marquis Corp. proves defective. Stereo components including radio, speakers, subwoofer, mechanical speaker lift device, stereo access door, power supply are warranted against defects in material and workmanship for one year. Labor to replace stereo components is covered for 90 days. Water intrusion of any kind is not covered. All materials for examination must be returned to Marquis Corp. freight prepaid.

Your authorized Marquis® Dealer reserves the right to assess travel charges for service calls.

INVALIDATION OF WARRANTY

This warranty is void if the stereo system has been subjected to alteration, misuse or abuse or if any repairs on the stereo system are performed or attempted by anyone other than an authorized Marquis Corp. service center. Alteration is defined as any component change, electrical conversion or the addition of any alternative sound system components which contribute to component failure.

Misuse and abuse shall include without limitation any external power source attached to the stereo system other than approved source, or use in a particular manner that the stereo system was not designed, or operation of the stereo system other than in accordance with Marquis Corp. printed instruction (located in the Owner's Manual) that leads to any component failure. Under no circumstances shall Marquis Corp. or any of its representatives be held liable for injury to any person or damage to any property, however arising.

Other costs not associated to the direct repair of the spa, such as phone charges, missed work, and damage caused to the stereo system beyond Marquis® control, are not included in this warranty. Items beyond Marquis® control include but are not limited to damage resulting from: improper connections, accidents, failure to follow procedures defined in the Owner's Manual, damaged from excessive wattage to the system, lightning, extreme temperatures or any other natural occurrences.

IMPORTANT: Some jurisdictions do not allow the exclusion or limitation of incidental or consequential damages, therefore the limitation or exclusions may not apply to you.



MARQUIS

VECTOR21 STEREO SYSTEM LIMITED WARRANTY

DISCLAIMERS

There are no additional warranties, express or implied, which extend beyond the terms of this limited warranty. Marquis Corp. makes no warranty of merchantability of the goods or the fitness of the goods for a particular purpose.

No other person or entity has been authorized to make any warranty, representation or promise of performance not included in this express written warranty, and Marquis Corp. shall not be bound by any such additional warranty, representation or promise.

This warranty gives you specific legal rights. You may also have other rights that may vary from state to state.