



WELCOME TO THE ULTIMATE HOT TUB EXPERIENCE!

We sincerely hope your spa life is a pleasant experience. If problems should arise, contact your authorized Marquis® dealer. Or contact Marquis Corp. at any of the following:

Email: service@marquiscorp.com
 Web: www.marquisspas.com
 Marquis Corp.
 596 Hoffman Road
 Independence, OR 97351, USA

This manual is provided to enhance your enjoyment of your spa and to prevent non-warranty situations. It is your sole responsibility to read, understand and comply with the instructions in the owner's manual. Please save your original sales receipt for reference in case of a future warranty claim. Failure to use, maintain or install the spa in compliance with this owner's manual could result in loss of warranty coverage.

SERIAL NUMBER LOCATION

You will find the serial number on the tag in the equipment area.

PLEASE FILL OUT AND KEEP FOR FUTURE REFERENCE

Name of Purchaser _____

Date of Purchase _____

Address _____

City _____ State _____ Zip Code _____

Telephone _____

Spa Model/Color _____

Spa Serial # _____

Pack Serial # _____

Dealer's Name _____

Dealer's Address _____

City _____ State _____ Zip Code _____

Telephone _____

Every effort has been made to ensure the accuracy of this manual. However, Marquis® reserves the right to improve its product without notice. This could create a minor variation between this manual and the actual product you receive. We apologize for any inconvenience this may cause.

• IMPORTANT SAFETY INSTRUCTIONS	
240V, Permanently Installed Models	3
All Spa Models	3-5
Personal Safety	6
• INSTALLATION INSTRUCTIONS	
Location	7-8
Filter Cartridges	9
Electrical Requirements	10-11
• STARTING YOUR HOT TUB	12-14
• MARQUIS® HOT TUB MODELS	
Summit.....	15-16
Epic.....	17-18
Euphoria.....	19-20
Resort.....	21-22
Destiny.....	23-24
Wish.....	25-26
Spirit.....	27-28
• MARQUIS® SPA CONTROL OPERATION	
All Models.....	29-42
• MARQUIS® MESSAGES & DIAGNOSTICS	
Messages.....	43-46
• MARQUIS® EQUIPMENT DIAGRAMS	
Summit.....	47
Epic & Euphoria.....	48
Resort.....	49
Destiny.....	50
Wish.....	51-52
Spirit.....	53
• MAINTENANCE ALL MODELS	54-59
• SPA CARE AND ENJOYMENT GUIDE ALL MODELS	60-67
• ENVIRONMENTS™ STEP ASSEMBLY INSTRUCTIONS	68
• MARQUIS® OWNER'S PROTECTION PLAN	69-71

The following instructions contain important safety information. We strongly encourage you to read and apply them.

IMPORTANT SAFETY INSTRUCTIONS

WHEN INSTALLING AND USING THIS ELECTRICAL EQUIPMENT, BASIC SAFETY PRECAUTIONS SHOULD ALWAYS BE FOLLOWED, INCLUDING THE FOLLOWING:

1. READ AND FOLLOW ALL INSTRUCTIONS

- WARNING:** To reduce the risk of injury, do not permit children to use this product unless closely supervised at all times.
- DANGER: RISK OF CHILD DROWNING.** Extreme caution must be exercised to prevent unauthorized access by children. To avoid accidents, ensure that children cannot use the spa or hot tub unless they are supervised at all times.

240 VOLT, PERMANENTLY INSTALLED MODELS

- A ground terminal is provided on the control box. To reduce the risk of electric shock, connect this terminal to the grounding terminal of your electrical service or supply panel with a continuous green, insulated copper wire. The wire must be equivalent in size to the circuit conductors supplying the equipment. In addition, a bonding terminal (pressure wire connector) is provided on the outside of the control box for bonding to local ground points. To reduce the risk of electric shock, this connector should be bonded with a No. 8 AWG (8.42mm²) (No. 6 AWG in Canada) solid copper wire to any metal ladders, water pipes, or other metal within five feet (1.52m) of the spa to comply with local requirements.
- Your spa uses ground fault circuit interrupters in the electrical sub-panel. Before each use of the spa and with the unit operating press the Test button on each breaker. The switch should click over to the "Trip" position. Wait thirty seconds and reset each GFCI breaker by switching it completely off and then completely on. The switch should then stay on. If either of the interrupters does not perform in this manner, it is an indication of an electrical malfunction and the possibility of an electric shock. Disconnect the power until the fault has been identified and corrected.

ALL SPA MODELS

- Install the spa so proper drainage is provided.
- DANGER: RISK OF ELECTRIC SHOCK.** Install the spa at least five feet (1.52m) away from metal surfaces, in accordance with the National Electric Code ANS/NMFP70-1993. Each metal surface must be permanently connected to a minimum No. 8 (8.42mm²) (No. 6 AWG in Canada) solid copper conductor attached to the wire bonding connector on the terminal box provided for this purpose.
- DANGER: RISK OF ELECTRIC SHOCK.** Do not permit any appliance, such as a light, telephone, radio, or television, etc. within five feet (1.52m) of the spa or hot tub.

9. **WARNING:** To reduce the risk of injury:
- Water temperatures between 100°F (38°C) and 104°F (40°C) are considered safe for a healthy adult. Lower water temperatures are recommended for extended use (exceeding 10 minutes) and for young children.
 - Since excessive water temperatures have a high potential for causing fetal damage during the early months of pregnancy, pregnant or possibly pregnant women should limit spa water temperatures to 100°F (38°C).
 - Before entering a spa, the user should measure the water temperature with an accurate, water-proof, fever thermometer since the tolerance of temperature-regulating devices may vary as much as +/- 5°F (3°C).
 - The use of drugs, alcohol, or medication before or during spa use may lead to unconsciousness with the possibility of drowning.
 - Persons suffering from obesity or with a medical history of heart disease, low or high blood pressure, circulatory system problems, or diabetes should consult a physician before using the spa.
 - Persons using medications should consult a physician before using a spa since some medication may induce drowsiness while other medication may affect heart rate, blood pressure, and circulation.
10. **DANGER: TO REDUCE THE RISK OF INJURY TO PERSONS.** Do not remove the suction fittings.
11. **DANGER: RISK OF INJURY:** Never operate a spa if the suction guard(s) is broken or missing. Never replace a suction guard with one rated less than the flow rate marked on the original suction guard. The suction guard(s) in the spa are sized to match the specific water flow created by the pump. Should the need arise to replace the suction guard(s) or the pump, be sure that the flow rates are compatible.
12. **DANGER:** Children are especially sensitive to hot water. At no time should children have unsupervised access to the spa. Children must not be allowed to climb onto the spa cover. All Marquis spas are equipped with a locking cover that meets the ASTM F1346-91 Standard for Safety Covers. Always lock the child resistant locks after using the spa for your children's safety.

13. **SAVE THESE INSTRUCTIONS.**

WARNING: Do not permit electric appliances (such as a light, telephone, radio, or television) within five feet (1.52m) of the spa or hot tub.

WARNING: Children should not use spas or hot tubs without adult supervision.

WARNING: Do not use spas or hot tubs unless all suction guard(s) are installed to prevent body and hair entrapment.

WARNING: Do not use drugs or alcohol before or during the use of a spa or hot tub to avoid unconsciousness and possible drowning.

WARNING: People using medications and/or having an adverse medical history should consult a physician before using a spa.

WARNING: The use of alcohol, drugs, and medication can greatly increase the risk of fatal hyperthermia.

WARNING: Before entering the spa or hot tub measure the water temperature with an accurate thermometer.

WARNING: Water temperature in excess of 104°F (40°C) may be injurious to your health.

WARNING: Prolonged immersion in a spa or hot tub may be injurious to your health.

WARNING: People with infectious diseases should not use a spa.

WARNING: Pregnant or possibly pregnant women should consult a physician before using a spa or hot tub.

WARNING: To avoid injury, exercise care when entering and exiting the spa or hot tub.

WARNING: Do not use a spa or hot tub immediately following strenuous exercise.

WARNING: Maintain water chemistry in accordance with manufacturer's instructions.

PERSONAL SAFETY

Prolonged immersion in hot water can result in HYPERTHERMIA, a dangerous condition which occurs when the internal temperature of the body reaches a level above normal (98.6°F, 37°C). The symptoms of hyperthermia include dizziness, fainting, drowsiness, lethargy, and a body temperature above 98.6°F (37°C). The physical effects of hyperthermia include unawareness of impending hazard, failure to perceive heat, failure to recognize the need to exit the spa, physical inability to exit the spa, fetal damage in pregnant women, and unconsciousness resulting in a danger of drowning.

WARNING: The use of alcohol, drugs, or medication can greatly increase the risk of fatal hyperthermia in hot tubs and spas.

Persons taking medications which induce drowsiness such as tranquilizers, antihistamines, or anticoagulants should not use the spa. Pregnant women and persons with a medical history of heart disease, diabetes, or high blood pressure should consult a physician before using the spa.

PERSONAL SAFETY DOs:

- Be sure your spa is connected to the power supply correctly – only use a licensed electrical contractor.
- Shut off power supply before draining the spa or servicing the electrical components.
- Test the Ground Fault Circuit Interrupter (GFCI) monthly.
- Always test the water temperature with an accurate thermometer before entering the spa to be sure that it's a safe temperature.
- Do not use the spa if water temperature is outside of set temperature. Remember that wet surfaces can be very slippery. Take care when entering and exiting the spa.
- Lock the DuraCover™ when the spa is not in use, whether it is empty or full of water.
- Keep the water clean and sanitized with correct chemical care.
- Turn on the jets when adding ANY chemicals to the spa water.
- Clean the filter cartridge(s) monthly to remove debris and mineral buildup which affects the performance of the hydrotherapy jets, limits the flow, or trips the high limit thermostat which will turn off the entire spa.

PERSONAL SAFETY DO NOTs:

- Don't use the spa with the equipment compartment door removed.
- Don't use the spa for more than 10 minutes of time at water temperatures in excess of 102°F (39°C).
- Don't allow the jet pump(s) to operate for an extended period of time with the cover in place. Extended pump operation causes a slow heat buildup due to water friction. The spa equipment controls are equipped with a built-in safety timer that automatically shuts off the jet pump(s) after 15 minutes of continuous operation should it have been left on inadvertently.
- Don't operate the spa at any time with the filter cartridges removed.
- Don't lift or drag the cover by using the tie-down straps; always lift and carry by using the external handles.
- Don't store chemicals in the spa's equipment compartment.
- Don't hesitate to call your authorized dealer with any questions or maintenance concerns.

LOCATION

For your portable spa to function properly and safely, it must be located on a hard, flat, level surface. Inground spas require special installation techniques and should be planned in conjunction with your authorized Marquis® dealer. Improper installation can result in structural damage to the spa and the voiding of your spa warranty. Items to discuss with your dealer include: Local construction codes, electrical service requirements, serviceability of equipment present underground obstructions such as gas, water, and telephone lines, safety measures such as fences and locks, and visibility of the spa installation from the home, street, and neighbors.

Do not shim your spa. If your pad is not level you must pour a top cap: contact a professional.

- Allow for sufficient water drainage around the spa to help preserve the equipment and support structure. This includes indoor installations.
- A filled spa can weigh over 5,000 pounds, excluding bathers and the location should support the weight of the filled spa.
- Locate the equipment compartment where it will be accessible. Your spa **MUST** be installed to permit access for servicing the equipment above and/or below any decks or floors. Access is essential and must allow adequate room for service. To facilitate repairs, Marquis Corp. or its agent may require access to spa equipment. It is your responsibility to provide unencumbered access. See spa diagrams for location of power supply.
- Leave access to the circuit breakers in the sub panel (240V models) or to the interrupter switch.
- Be sure the spa is level and in the final position **BEFORE** filling with water. Check for power cords, tools, and hoses that may be caught underneath the spa. Do not apply power to the spa before it is completely filled with water. Damage to the pumps, heater and sensors may result.
- **IMPORTANT: DO NOT LET AN EMPTY SPA REMAIN EXPOSED TO DIRECT SUNLIGHT.** Spa surface temperatures can reach in excess of 180°F (82°C) if left exposed to the sun. Significant damage can occur to the acrylic if this is allowed to happen, including warping and blistering of the surface. Damage, that occurs as a result of this exposure, is not covered under the warranty.
- **CAUTION:** Never try to move a spa that has not been fully drained. To do so could result in damage to the spa and physical injury to the mover. Cracks in the spa surface, exterior siding or DuraBase due to improper transport or support of the spa are not covered under the warranty.

OUTDOOR AND PATIO INSTALLATION

To install the spa outdoors, we recommend a reinforced concrete pad at least four inches thick. The reinforcing material should be attached to a #8 AWG (6AWG for Canada) bonding wire per national and local electrical code.

If you place the spa on the ground, even temporarily, place the spa empty of water on concrete pavers under the entire bottom of the spa. The concrete pavers should be at least two inches thick and level across the entire surface. The spa will inevitably settle and not remain level on this surface, thus it's important to get the spa onto a solid foundation as soon as possible.

INSTRUCTIONS FOR PREFABRICATED SPA PADS

To use a prefabricated spa pad for a foundation, follow these guidelines:

1. Designate the area where the spa is to be installed. Please make sure the ground is flat and level.
2. Using 2"x 6" (51mm - 152mm) weather resistant lumber and 3" (76mm) outdoor deck screws, build a frame large enough for the prefabricated spa pad to fit inside with minimum 1" (25mm) clearance on all sides.
3. Install the frame in the area that has been leveled.
4. Using crushed gravel, fill the frame to the top.
5. Lay a straight piece of lumber across the frame and level any high spots in the gravel by pushing the straight lumber across the frame. Fill in any low areas with more gravel and re-level using the straight piece of lumber.
6. Compact the gravel to make the surface is hard and flat. You may need to add more gravel to bring the level back up to the top of the frame. If so, please re-level and re-compact until you have a hard, flat level surface that is even with the top of the frame.
7. Place the prefabricated spa pad on top of the gravel. Please be careful not to disturb the hard, flat, level surface.
8. Please make sure no portion of the spa pad is sitting outside or on top of the framing.
9. Place the spa on top of the pad and fill the spa with water.

DECK INSTALLATION

Be sure the deck can support the weight of your filled spa by checking the deck's maximum load capacity. Consult a qualified building contractor or structural engineer. Minimum requirement is 100 lbs. (45 kg) per square foot.

INDOOR INSTALLATION

There are special requirements if you place your spa indoors. Flooring material must provide adequate traction when wet. Proper drainage is essential to prevent water puddling. Proper ventilation to the area is required. The addition of a ventilation system is recommended. Please see your contractor for details.



Shut-off valve in open position

SHUT-OFF VALVES

Your spa is equipped with shut-off valves (see EQUIPMENT DIAGRAM) that shut off the water flow to the equipment system for authorized Marquis® dealer service. At times, a new spa or one that has recently been serviced, may have the shut-off valves partially closed which can restrict the water flow and hinder jet performance. Be sure the valves are fully open.

FREEZE PROTECTION

When a freeze condition is detected (which occurs when the temperature in the heater housing drops to 55°F, (13°C) the jet pump(s) is automatically activated. In areas with extremely cold winter conditions, your spa should be fine as long as it is left running at normal operating temperatures. For extra protection see your dealer for an optional freeze sensor. If you plan to turn the spa off, follow the instructions in this manual (see SUSPENDED USE OR WINTERIZING YOUR SPA).

OVERHEATING

In the case of extended hot weather, the spa water temperature may reach and maintain 104°F to 106°F (40°C to 41°C) or higher. This is due to the ambient temperature and the full insulation in the spa cabinet. You have the option of changing when or how long the pumps will run. See SPA CONTROL OPERATION for available options.

FILTER CARTRIDGES

Your portable spa is equipped with the ConstantClean™ Filtration system. It features one or two Vortex filters.

NOTE: It is very important that the components of these filtration systems be installed properly in the proper part of the spa.

1. Remove filter cover.
2. Hold the Vortex filter cartridge and center it in the opening of the filter housing.
3. Use the filter handle and turn the filter cartridge clockwise to screw it in place. (Use caution not to overtighten as damage may occur to threads and is not covered under warranty.)
4. Replace the filter cover.

SUCTION GUARDS

The suction guard(s) in the footwell of your spa is an opening through which the jet pump(s) draws water. The suction fittings have an integrated vacuum release built into them. In the event that a suction fitting gets blocked, air will be induced causing the pump to cavitate and the water flow interrupted. Once the blockage is removed, normal operation will resume. Suction fittings are equipped with a safety guard. Suction through the fittings can be strong. The safety guard(s) must remain in place and undamaged. A fitting with a damaged guard(s) can be dangerous, especially to small children or people with long hair. Should any part of the body become drawn to a fitting, turn the jet pump(s) off immediately. Long hair should be restrained. Never allow long hair to float freely in the spa. Replace any missing or damaged suction guard(s).



Safety guard of suction fitting must remain in place.

NOTE: It is normal for the flow rates of the suction fittings to vary from strong to barely noticeable.

ELECTRICAL REQUIREMENTS

It is the responsibility of the spa owner to ensure that all electrical connections are made by a qualified electrician in accordance with all national, state, and local electrical codes in effect at the time of installation. Fuses are covered to be free of defect at time of installation only.

240 Volt

All connections must be made in accordance with the wiring diagram found on the inside of the control box cover. Connections must be made with copper conductors only – *do NOT use aluminum wire*. All conductors, circuit breakers, and fuses and the GFCI must be sized in accordance to the total amperage load as specified below.

Improperly wired spas can cause irreversible damage resulting in blown fuse and melted terminal block, and to other electrical components. Also, damage caused to components or equipment caused by high or low voltage, brown outs or electric surges is not covered under warranty.

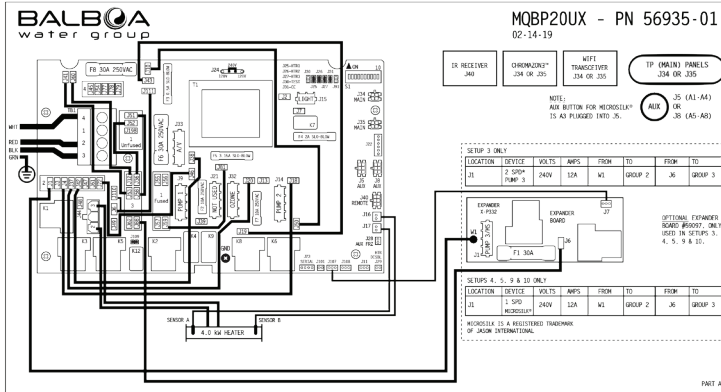

- Permanently connected (Hard wired).
- Rated 240V, 60Hz, 50A, three wires (#6 copper) plus ground (#8 copper (8.42mm²)), [4 wires total].
- Circuit breaker or fuse size: 50A.
- A disconnecting means must be installed within sight from the equipment and at least 5 feet (1.52m) from the inside walls of the spa.
- Connect only to a circuit protected by a Class A ground Fault Circuit Interrupter (GFCI).

Red (hot) wire connected to #2 on terminal block.

Black (hot) wire connected to #3 on terminal block.

White (neutral) wire connected to #4 on terminal block.

Green (ground) wire routed through plastic enclosure and secured to exterior bonding lug.

Improperly wired spas are beyond Marquis Corp. control and are not covered under the warranty.

Other items beyond Marquis Corp. control include, but are not limited to, damage resulting from: improper connections; accidents; failure to follow procedures and instructions defined in the Marquis® printed instructions; cleaning agents; and natural occurrences including but not limited to rodent or insect infestation, mold, lightning and other acts of nature.

STARTUP PROCEDURE

Your spa is equipped with solid-state Comfort Controls specific to your spa model. (See **SPA CONTROL OPERATION** for your specific spa model.) **NOTE:** Your spa has been filled and test-run at the factory. The first time your spa is filled with water, some discoloration from residual test water may appear. This will disappear when the spa is completely filled and the filtration system is functioning.

THERAPY PUMP(S)

Startup procedure for all models

1. Place spa on a hard, flat, level surface. Make sure the power supply is off.
2. Make sure the suction guard(s) in the footwell are in place and undamaged.
3. Open the equipment door. Tighten all disconnects and open all shut-off valves.

NOTE: Keep the drain valve closed at all times except when draining the spa (do not rely on the cap to stop the flow of water). Not doing so could result in damage to the drain valve due to freezing water.

4. Install filter cartridges. (See **INSTALLATION INSTRUCTIONS**, Filter Cartridges.)
5. Fill the spa with water to two-thirds of the way up the Vortex skimmer openings. The use of a *Fill Filter* is recommended, especially in areas with high mineral content in the water.
6. Turn the power on.

WARNING: Spa must be completely filled with water before turning on power.

7. Your spa is now in “pump priming” mode and a “Priming Mode” message displays in the LCD window of the control panel. While in this mode the spa appears idle, which lasts approximately four to five minutes if not exited manually. To exit manually, press the back arrow in the lower left corner of the display.
8. Allow the spa to circulate on high-speed (see **SPA CONTROL OPERATION**) for four to five minutes to discharge air from the plumbing system. Do not expect hot water immediately from the jets; the heater will take several hours to heat the water.



Vent air by slightly opening pump unions.

9. At this time the spa should have water flowing from the jets. If the pump has not primed and the water is not flowing from the jets after two minutes TURN OFF POWER TO THE SPA and vent air from the pumps by slightly opening the pump unions located behind the equipment door. After turning the power on again, the spa initiates a new priming mode. Repeat steps above.

10. The system requires approximately two minutes of water flow to determine the water temperature. After two minutes of water flow, the temperature is displayed as actual water temperature. After you have manually exited the priming mode (or allowed the spa to automatically exit) the LCD window momentarily displays 100°F (38°C) and then the display switches to - - °F.

11. The factory default setting for water temperature is 100°F (38°C). Use the TEMP pads on the control panel to set the water temperature to the desired level. (See SPA CONTROL OPERATION.) It takes up to 24 hours to heat the water to desired temperature depending on the water temperature and voltage of your spa.

Test the water for the proper chemical balance and adjust as necessary. Marquis® SpaCare products are recommended. (See **WATER TREATMENT.**) **PROPER CHEMICAL BALANCE IS IMPORTANT** for your safety and the longevity of your spa.

WEATHERSHIELD™ COVER

When the spa is not in use, the cover should be kept on the spa to retain the water's heat and to keep out dirt, leaves, etc.

For your safety and convenience, the cover is equipped with straps, safety locks, and handles. Use the exterior handles to remove and replace your cover after breaking the vacuum seal with one hand. Never attempt to open or remove the cover by grasping or pulling on the cover skirting or cover lock straps as the skirting will tear.

Marquis® suggests you use the safety locks to help keep out unintended users, prevent covers from being blown off in windy conditions and to maximize heat retention/energy efficiency. The cover and retractable cover system are not recommended for use in wind conditions reaching above 25 miles per hour. If your spa is located in an area susceptible to high winds, additional Hold-Down wind straps may be necessary to minimize cover damage.

NOTE: Marquis®' exclusive cover is designed for optimum protection of the spa shell. Using an aftermarket cover will not provide the same protection and will void the shell warranty.

Open the spa cover:

1. Unfasten all cover lock straps.
2. Place one hand under the cover skirting, between the spa and cover, to break the cover's vacuum seal. Do not use cover handles to break vacuum seal.
3. Fold the front half of the cover over onto the back half.

NOTE: Unlock and release all cover locks before attempting to open cover. Damage caused by attempting to open the cover while locked or by wind is not covered under warranty. Do not walk, stand, climb, or sit on the vinyl cover or retractable cover system. Do not use hard, sharp, or metal objects, such as a windshield scraper, to remove ice. Such objects can cut, mar, or puncture the cover's vinyl surface.

Close the spa cover:

1. Slide folded cover onto one half of spa.
2. Unfold the cover by lifting the handle located on the top (front) half of the cover. Allow the unfolded half to gently drop down onto the spa.
3. Secure the cover lock straps to the spa and lock them.

NOTE: When opening a cover with a cover removal mechanism, use one of the manufacturer's recommended methods. Do not attempt to open the cover in any other way. Damage caused by improper opening or closing of the cover is not covered under the warranty. Fading, staining, torn stitching of the spa cover and broken foam cores are not covered under the warranty for any reason. Spa covers do not qualify for labor coverage under the warranty. These parts may be purchased or exchanged under warranty at your authorized Marquis® Dealer.

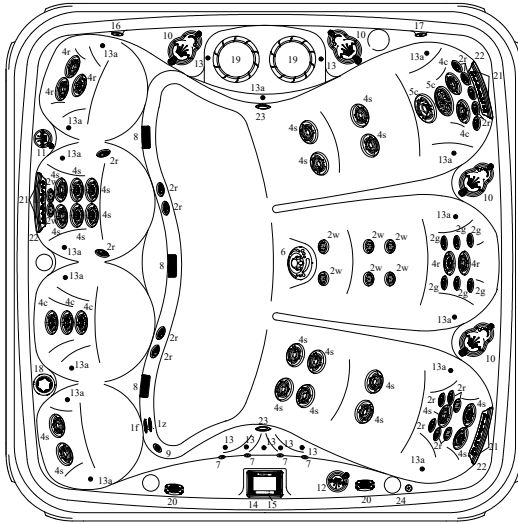

#	Component Identification	Qty.
1f	In-line Fitting	1
1z	Ozone Fitting	1
2w	RKJ 20 Target Touch	8
2r	RKJ 20	17
2g	RKJ 40	6
4s	RKJ Target Touch	21
4r	RKJ Pulse Touch	5
4c	RKJ Multi-Touch	5
5c	RKJ Multi-Touch	2
6	RKJ Whitewater-4™	1
7	Waterfall Features	4
8	Suction Fittings	3
9	Floor Drain	1
10	Dynamic Flow Control Valves	4
11	Neck Jet Valve	1
12	Waterfall Valve	1
13	LED Light	7
13a	Jewel™ Lighting (option)	15
14	MQTouch Control Panel	1
15	MQTouch Bezel	1
16	Pump 1 Auxiliary Control	1
17	Pump 2 Auxiliary Control	1
18	In-Line Dispenser	1
19	Filter Canisters	2
20	Speakers (optional)	2
21	Headrest Buttons	6
22	Headrests	3
23	MicroSilk® Return Fittings (option)	2
24	MicroSilk Air Intake Fitting (option)	1

Physical Specifications	US/CAN	INTL
Size	94 in x 94 in	239 x 239 cm
Height	36 in	90 cm
Therapy Seats	7	7
Weight Dry	1100 lb	499 kg
Weight Full	5020 lb	2277 kg
Water Capacity	470 Gal	1779 l
Total Therapy Jets	65	65

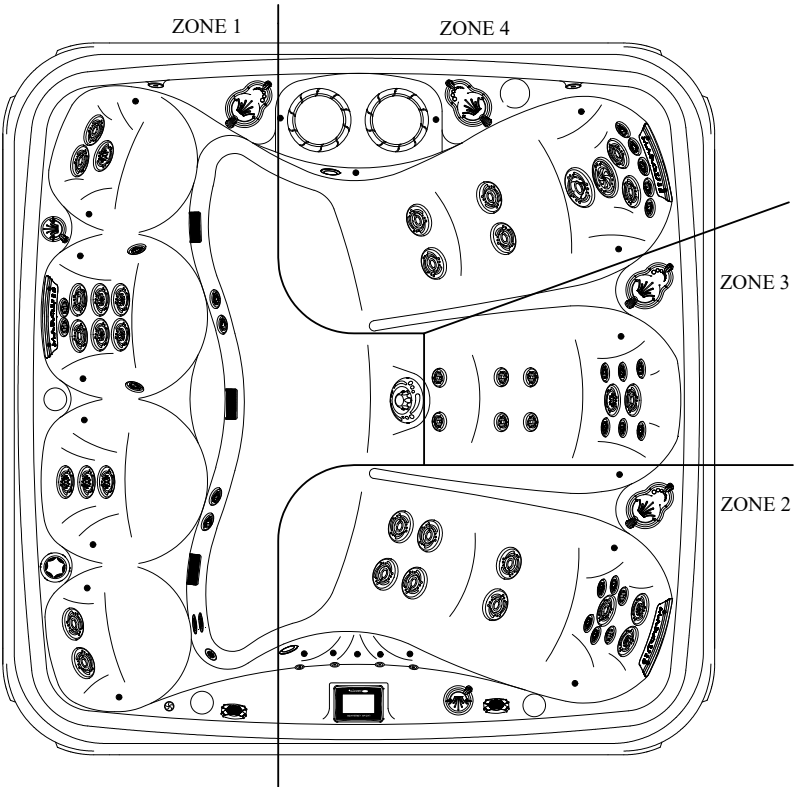

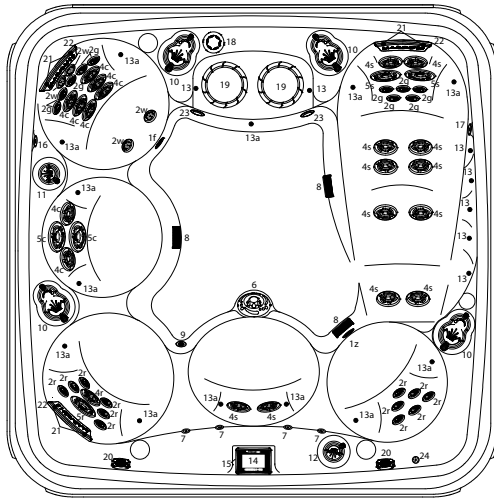

#	Component Identification	Qty.
1f	In-line Fitting	1
1z	Ozone Fitting	1
2w	RKJ 20 Target Touch	4
2r	RKJ 20	12
2g	RKJ 40	10
4s	RKJ Target Touch	12
4r	RKJ Pulse Touch	1
4c	RKJ Multi-Touch	8
5s	RKJ Target Touch	2
5r	RKJ Pulse Touch	1
5c	RKJ Multi-Touch	2
6	RKJ Whitewater-4™	1
7	Waterfall Features	4
8	Suction Fittings	3
9	Floor Drain	1
10	Dynamic Flow Control Valves	4
11	Neck Jet Valve	1
12	Waterfall Valve	1
13	LED Light	7
13a	Jewel™ Lighting (option)	13
14	MQTouch Control Panel	1
15	MQTouch Bezel	1
16	Pump 1 Auxiliary Control	1
17	Pump 2 Auxiliary Control	1
18	In-Line Dispenser	1
19	Filter Canisters	2
20	Speakers (optional)	2
21	Headrest Buttons	6
22	Headrests	3
23	MicroSilk® Return Fittings (option)	2
24	MicroSilk Air Intake Fitting (option)	1

Physical Specifications	US/CAN	INTL
Size	90 in x 90 in	229 x 229 cm
Height	36 in	90 cm
Therapy Seats	6	6
Weight Dry	850 lb	386 kg
Weight Full	4103 lb	1814 kg
Water Capacity	390 Gal	1476 l
Total Therapy Jets	53	53

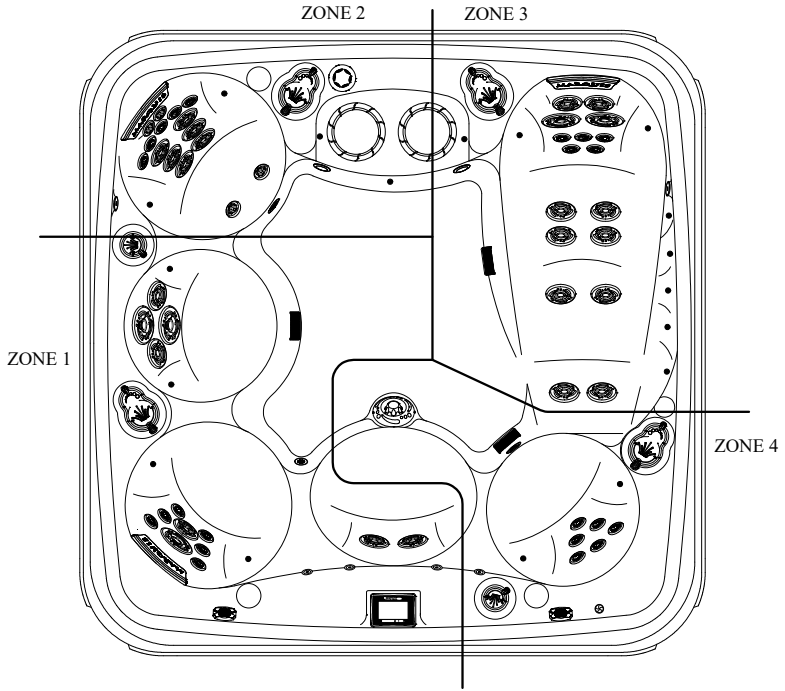

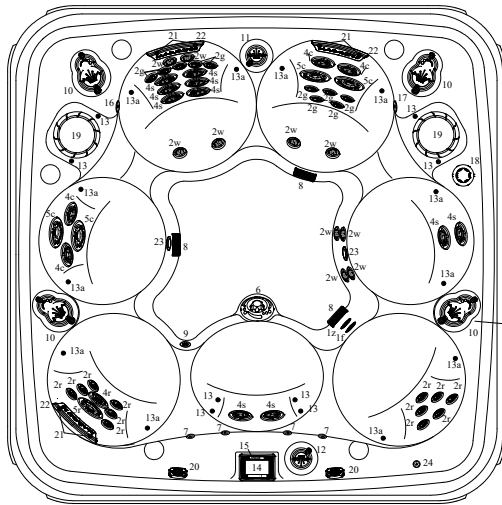

#	Component Identification	Qty.
1f	In-line Fitting	1
1z	Ozone Fitting	1
2w	RKJ 20 Target Touch	10
2r	RKJ 20	12
2g	RKJ 40	10
4s	RKJ Target Touch	10
4r	RKJ Pulse Touch	1
4c	RKJ Multi-Touch	4
5r	RKJ Pulse Touch	1
5c	RKJ Multi-Touch	4
6	RKJ Whitewater-4™	1
7	Waterfall Features	4
8	Suction Fittings	3
9	Floor Drain	1
10	Dynamic Flow Control Valves	4
11	Neck Jet Valve	1
12	Waterfall Valve	1
13	LED Light	8
13a	Jewel™ Lighting (option)	12
14	MQTouch Control Panel	1
15	MQTouch Bezel	1
16	Pump 1 Auxiliary Control	1
17	Pump 2 Auxiliary Control	1
18	In-Line Dispenser	1
19	Filter Canisters	2
20	Speakers (optional)	2
21	Headrest Buttons	6
22	Headrests	3
23	MicroSilk® Return Fittings (option)	2
24	MicroSilk Air Intake Fitting (option)	1

Physical Specifications	US/CAN	INTL
Size	90 in x 90 in	229 x 229 cm
Height	36 in	90 cm
Therapy Seats	7	7
Weight Dry	825 lb	374 kg
Weight Full	3994 lb	1812 kg
Water Capacity	380 Gal	1438 l
Total Therapy Jets	53	53

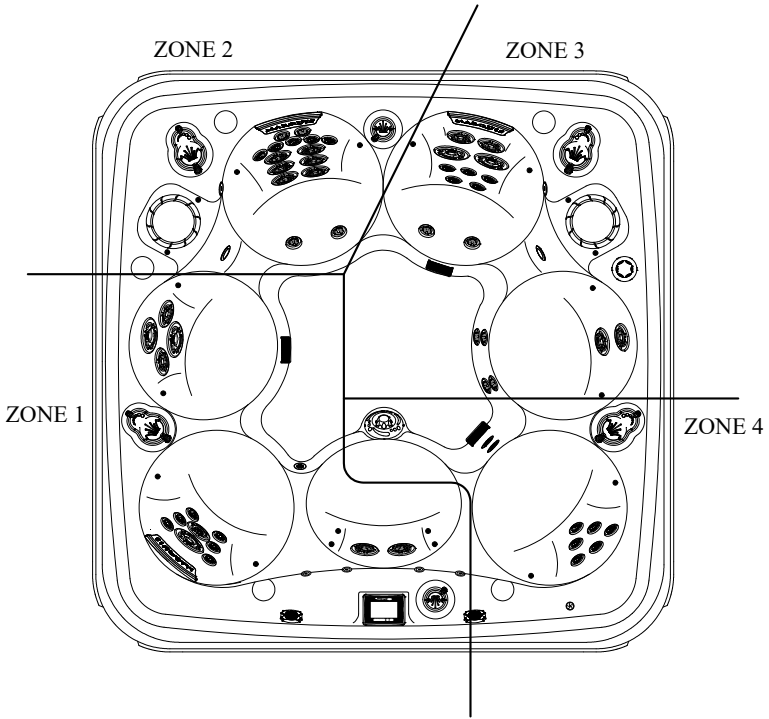

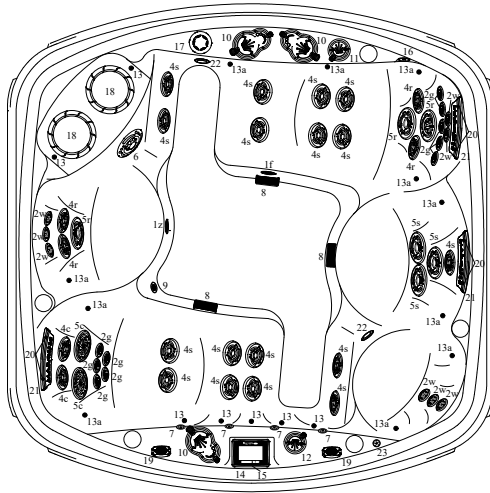

#	Component Identification	Qty.
1f	In-line Fitting	1
1z	Ozone Fitting	1
2s	RKJ 20 Target Touch	8
2g	RKJ 40	10
4s	RKJ Target Touch	17
4r	RKJ Pulse Touch	4
4c	RKJ Multi-Touch	2
5s	RKJ Target Touch	3
5r	RKJ Pulse Touch	3
5c	RKH Multi-Touch	2
6	RKJ Whitewater-4™	1
7	Waterfall Features	4
8	Suction Fittings	3
9	Floor Drain	1
10	Dynamic Flow Control Valves	3
11	Neck Jet Valve	1
12	Waterfall Valve	1
13	LED Light	7
13a	Jewel™ Lighting (option)	11
14	MQTouch Control Panel	1
15	MQTouch Bezel	1
16	Pump 2 Auxiliary Control	1
17	In-Line Dispenser	1
18	Filter Canisters	2
19	Speakers (optional)	2
20	Headrest Buttons	6
21	Headrests	3
22	MicroSilk® Return Fittings (option)	2
23	MicroSilk Air Intake Fitting (option)	1

Physical Specifications	US/CAN	INTL
Size	85 in x 85 in	216x216cm
Height	36 in	90 cm
Therapy Seats	5	5
Weight Dry	760 lb	345 kg
Weight Full	3762 lb	1706 kg
Water Capacity	360 Gal	1363 l
Total Therapy Jets	50	50

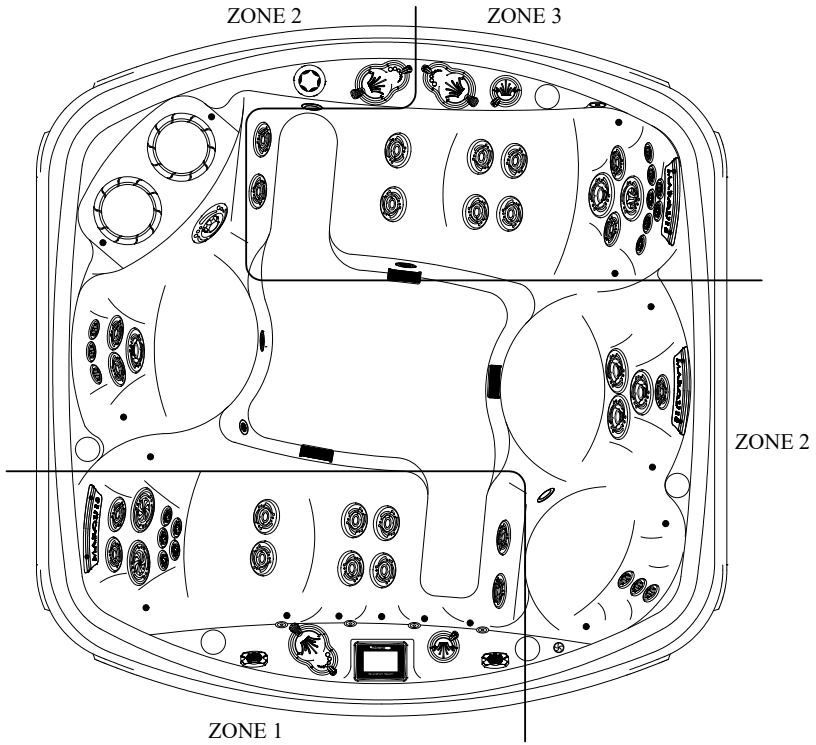

*Neck jets operate in all zones.

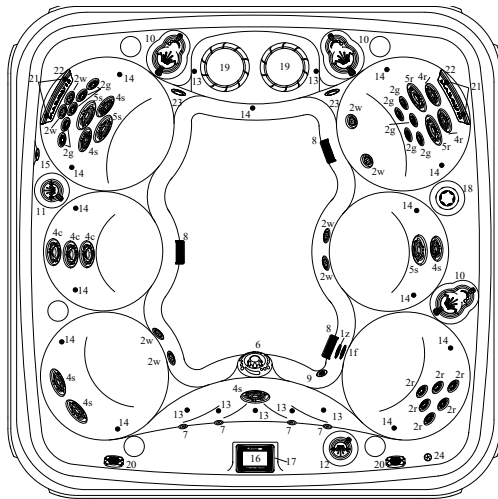

#	Component Identification	Qty.
1f	In-line Fitting	1
1z	Ozone Fitting	1
2w	RKJ 20 Target Touch	6
2r	RKJ 20	8
2g	RKJ 40	10
4s	RKJ Target Touch	6
4r	RKJ Pulse Touch	2
4c	RKJ Multi-Touch	3
5s	RKJ Target Touch	3
5c	RKJ Multi-Touch	2
6	RKJ Whitewater-4™	1
7	Waterfall Features	4
8	Suction Fittings	3
9	Floor Drain	1
10	Dynamic Flow Control Valves	3
11	Neck Jet Valve	1
12	Waterfall Valve	1
13	LED Light	7
14	Jewel™ Lighting (option)	13
15	Pump 1 Auxiliary Control	1
16	MQTouch Control Panel	1
17	MQTouch Bezel	1
18	In-Line Dispenser	1
19	Filter Canisters	2
20	Speakers (optional)	2
21	Headrest Buttons	4
22	Headrests	2
23	MicroSilk® Return Fittings (option)	2
24	MicroSilk Air Intake Fitting (option)	1

Physical Specifications	US/CAN	INTL
Size	85 in x 85 in	216 x 216 cm
Height	36 in	90 cm
Therapy Seats	7	7
Weight Dry	700 lb	318 kg
Weight Full	3289 lb	1492 kg
Water Capacity	310 Gal	1173 l
Total Therapy Jets	41	41

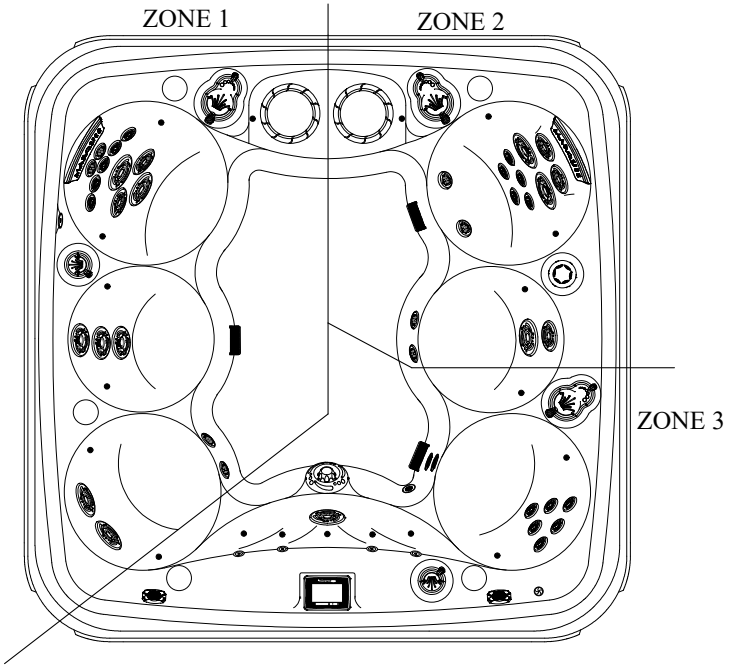

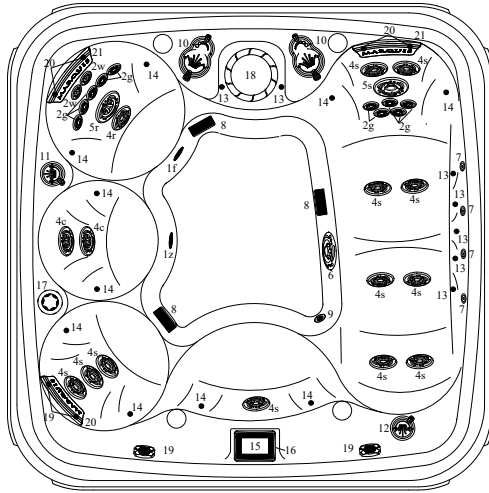

#	Component Identification	Qty.
1f	In-line Fitting	1
1z	Ozone Fitting	1
2w	RKJ 20 Target Touch	2
2g	RKJ 40	10
4s	RKJ Target Touch	12
4r	RKJ Pulse Touch	1
4c	RKJ Multi-Touch	2
5s	RKJ Target Touch	1
5r	RKJ Pulse Touch	1
6	RKJ Whitewater-4™	1
7	Waterfall Features	4
8	Suction Fittings	3
9	Floor Drain	1
10	Dynamic Flow Control Valves	2
11	Neck Jet Valve	1
12	Waterfall Valve	1
13	LED Light	7
14	Jewel™ Lighting (option)	10
15	MQTouch Control Panel	1
16	MQTouch Bezel	1
17	In-Line Dispenser	1
18	Filter Canister	1
19	Speakers (optional)	2
20	Headrest Buttons	6
21	Headrests	3

Physical Specifications	US/CAN	INTL
Size	77 in x 77 in	196 x 196 cm
Height	36 in	90 cm
Therapy Seats	5	5
Weight Dry	600 lb	272 kg
Weight Full	2771 lb	1257 kg
Water Capacity	260 Gal	984 l
Total Therapy Jets	43	43

WISH 1-PUMP

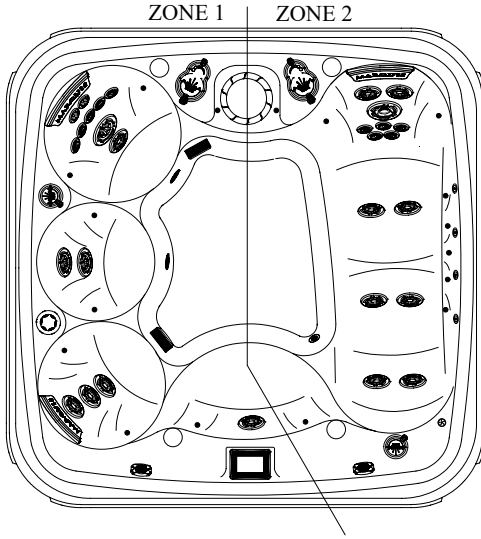

WISH 2-PUMP

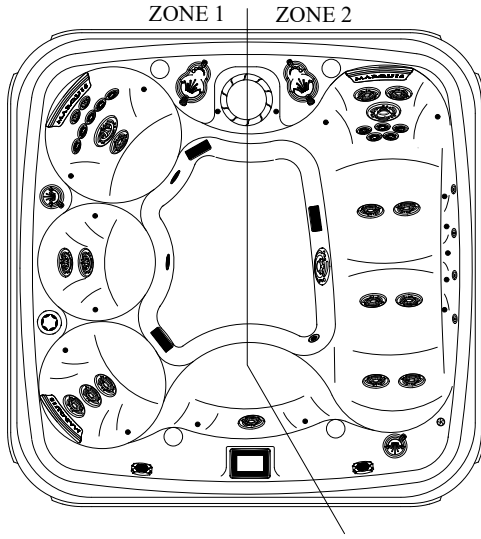

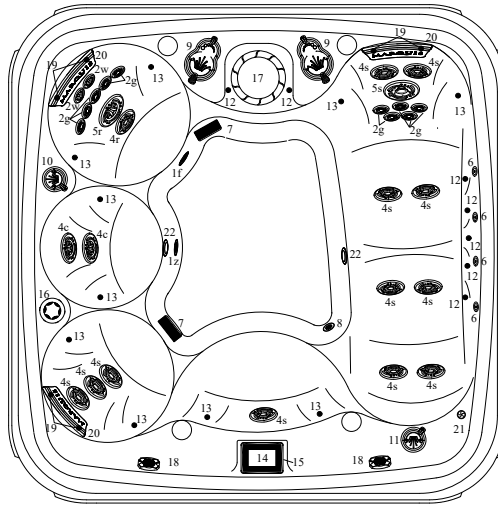

#	Component Identification	Qty.
1f	In-line Fitting	1
1z	Ozone Fitting	1
2w	RKJ 20 Target Touch	2
2g	RKJ 40	10
4s	RKJ Target Touch	12
4r	RKJ Pulse Touch	1
4c	RKJ Multi-Touch	2
5s	RKJ Target Touch	1
5r	RKJ Pulse Touch	1
7	Waterfall Features	4
8	Suction Fittings	2
9	Floor Drain	1
10	Dynamic Flow Control Valves	2
11	Neck Jet Valve	1
12	Waterfall Valve	1
13	LED Light	7
14	Jewel™ Lighting (option)	10
15	MQTouch Control Panel	1
16	MQTouch Bezel	1
17	In-Line Dispenser	1
18	Filter Canister	1
19	Speakers (optional)	2
20	Headrest Buttons	6
21	Headrests	3
23	MicroSilk® Return Fittings (option)	2
24	MicroSilk Air Intake Fitting (option)	1

Physical Specifications	US/CAN	INTL
Size	77 in x 77 in	196 x 196 cm
Height	36 in	90 cm
Therapy Seats	5	5
Weight Dry	550 lb	249 kg
Weight Full	2721 lb	1234 kg
Water Capacity	260 Gal	984 l
Total Therapy Jets	42	42

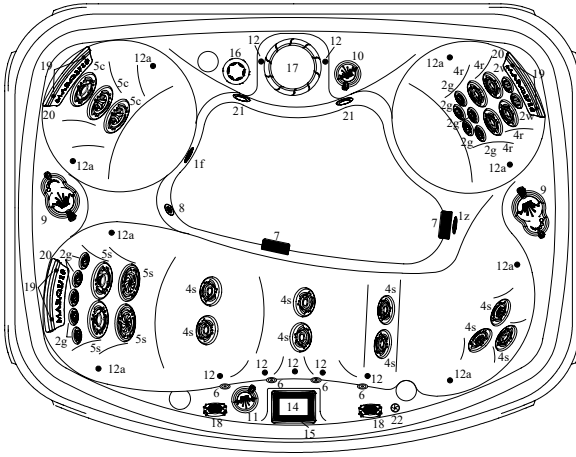

#	Component Identification	Qty.
1f	In-line Fitting	1
1z	Ozone Fitting	1
2s	RKJ 20 Target Touch	2
2g	RKJ 40	10
4s	RKJ Target Touch	9
4r	RKJ Pulse Touch	4
5s	RKJ Target Touch	4
5c	RKH Multi-Touch	3
6	Waterfall Features	4
7	Suction Fittings	2
8	Floor Drain	1
9	Dynamic Flow Control Valves	2
10	Neck Jet Valve	1
11	Waterfall Valve	1
12	LED Light	7
12a	Jewel™ Lighting (option)	8
14	MQTouch Control Panel	1
15	MQTouch Bezel	1
16	In-Line Dispenser	1
17	Filter Canister	1
18	Speakers (optional)	2
19	Headrest Buttons	6
20	Headrests	3
21	MicroSilk® Return Fittings (option)	2
22	MicroSilk Air Intake Fitting (option)	1

Physical Specifications	US/CAN	INTL
Dimensions	66 in x 85 in	168 x 213 cm
Height	36 in	90 cm
Therapy Seats	4	4
Weight Dry	460 lb	209 kg
Weight Full	2670 lb	1211 kg
Water Capacity	265 Gal	1003 l
Total Therapy Jets	32	32

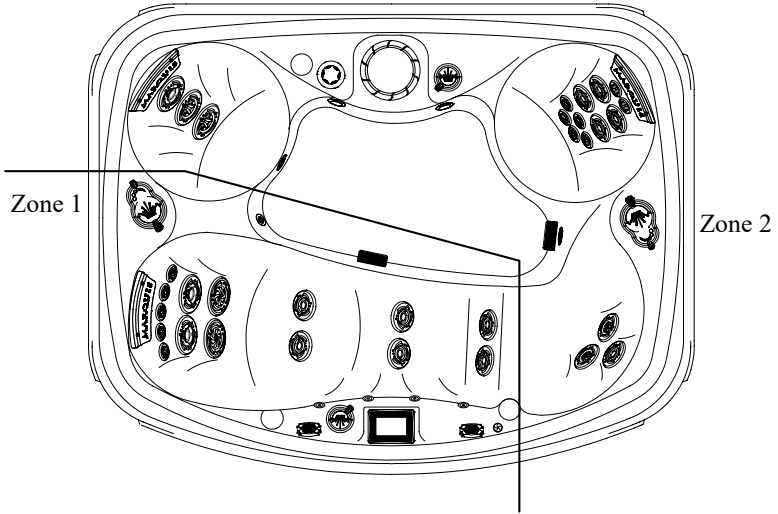

MAIN SCREEN ICONS

- A. Display off button: Touch this to turn off the display at any time.
- B. Heat Mode: R = Ready IR = Rest
- C. Ozone: If O₃ is being displayed, ozone is on. If it is not being displayed, it is off.
- D. Filter cycle: F₁ = filter cycle 1. F₂ = filter cycle two. If no icon is being shown, the unit is not in a programmed filter cycle currently.
- E. Smart Clean: Indicates the unit is in a smart clean clean-up cycle.
- F. Soak Feature: If the “S” is shown, the unit is in soak mode.
- G. Panel lock: If illuminated, the panel is locked. The panel can only be locked or unlocked via the Control-My-Spa app.
- H. Wi-Fi connection indicator: Shows signal strength of local connection if equipped.
- I. Time of day display: May be displayed in 12hr and 24hr modes.
- J. Current Water Temperature: May be displayed in F or C.
- K. Heater status: If red, the unit is calling for heat and the heater is on.
- L. Spa operation button: Touching this button will access pump, light and soak control.
- M. Jewel Lighting (Optional Feature): Touching this button will access the Jewel lighting control for interior and exterior lighting.
- N. Bluetooth Audio (Optional Feature): If equipped, touching this button will access the Bluetooth audio system.
- O. Settings button: Touching this will open the Settings screen to allow adjustment to various user settable features.
- P. Invert button: Touching this button will flip the operational screens 180 degrees. Some screens will not invert such as the Settings screen.



NOTE: References B through I are system indicators only. References A and, K through P, are functioning indicators that are activated when touched.

WAKING UP THE DISPLAY

The touchscreen panel will automatically turn off at a pre-set time. The factory default is 5 minutes but can be changed from 1 to 5 minutes in one minute increments. It can also be turned off manually on the main screen by touching the small crescent moon in the upper left hand corner of the screen.

- Touch the screen anywhere on the surface of the control panel
- The screen will wake up and a small hand pointing the “1” with a circle around it will be displayed. Touching that icon will open up a second screen
- Once the second screen has opened up, it will show a small hand pointing to the “2” with a circle around it. Touching that icon will wake up the screen and allow for full display and operation



NOTE: Sometimes the panel will react a little slower to the touch if either the panel surface or your fingers are very wet. Simply brushing off the water will allow for regular use in most cases.

HOT TUB CONTROLS



SETTING THE TIME OF DAY

To access the screen to set the time of day, please follow these steps.

Note: If you need to go back to a previous screen, touch the back arrow.

1. On the home screen, touch the Settings icon located on the bottom of the display

2. Touch the Time button

Back button

3. To adjust the time, use your finger to slide the scale up and down for hours, minutes and AM/PM. Once you have chosen the desired time, press the “check” mark to lock the time in. Should you decide to cancel the selection, touch the “X” to cancel.

Back button

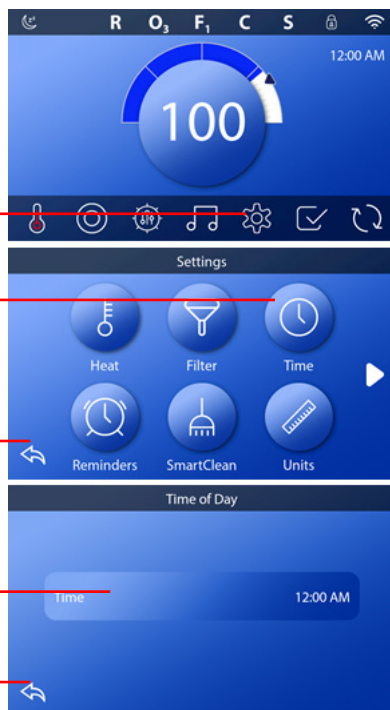

HOT TUB CONTROLS



SET THE TEMPERATURE

In this example we will set the Set Temperature to 102°F (39°C).

- Press the water temperature display button (A) to make the temperature menu appear (B). The center box with the arrow (C) indicates the current Set Temperature.
- If 102 (39) is already showing, but just not centered (D), touch it to center it (E).
- If 102 (39) is not showing (B), swipe the temperature menu until 102 (39) appears (D).
- If 102 (39) appears after swiping but does not stop in the center box (D), press 102 (39). Pressing 102 (39) makes it shift to the center box (E).
- Press the water temperature display (A) to make the temperature menu disappear. The Set Temperature is now 102 (39).

How do I know when the heater is On?

The center of the Heater Status icon turns red (A) when the heater is On. The Heater Status icon appears in the top left corner of the Spa screen when the heater is On.

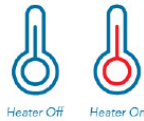

SETTING FILTRATION CYCLES

Should you want to change your factory default filtration settings, see the instructions below. The factory default settings are for two filtration cycles per day for 1.0 hour per cycle. The first cycle will start at 8:00 PM and the second cycle will start at 12:00 AM.

NOTE: If you need to go back to a previous screen, touch the back arrow.

1. On the home screen, touch the Settings icon located on the bottom of the display
2. Touch the Filter icon
3. To adjust the filter time, touch within the frame of the desired time box that you want to change. That will bring up the adjustment screen.

NOTE: If you do not want the second filtration time to run, touching the “2” will turn it off, followed by pressing the “check”. It will be active when the white ring illuminates around the number.

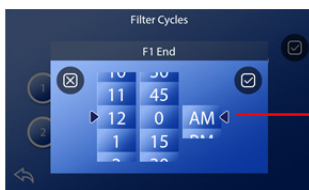
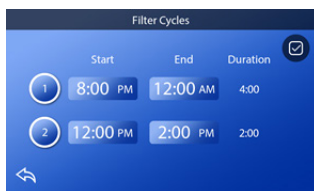
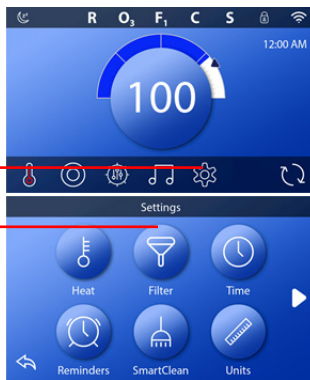

4. Use your finger to slide the scale up or down to the desired hours, minutes and AM/PM. Once selected, press the “check” mark to lock

the time in. Should you decide to cancel the selection, touch the “X” to cancel.

SETTING SMARTCLEAN RUN TIMES

Smart Clean is a clean-up cycle that will automatically activate 30 minutes after the last press of any button was made. This is helpful feature to keep water clean shortly after use. The run time choices range from 0 hours up to 4 hours in 30 minute increments. The factory default is 0.5 hrs.

Access the screen to change the length of run time:

1. On the home screen, touch the Settings icon located on the bottom of the display
2. Touch the SmartClean icon
3. To adjust run time, touch SmartClean button and it will open up another screen with the run-time selections. Use your finger to slide the scale up and down. Once you have chosen the desired run time, press the “check” mark to lock the time in. Should you decide to cancel the selection, touch the “X” to cancel.

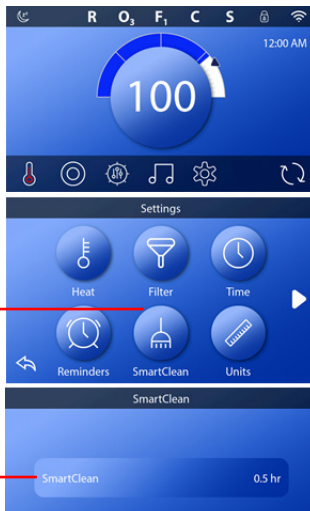

HOT TUB CONTROLS



SETTING THE UNITS

Features found in the Units screen allow for changing how the temperature scale and time are displayed on the home screen.

To access the screen to make these changes, please follow these instructions

1. On the home screen, touch the Settings icon located on the bottom of the display
2. Touch the Units button
3. To change the temperature display from Fahrenheit to Celsius, touch the "Temp Display" box to toggle between the two choices.
4. To change the way the time is displayed, touch "Time Display" box to toggle between 12HR and 24HR.
5. To save and return to the Settings screen, press the back button two times.

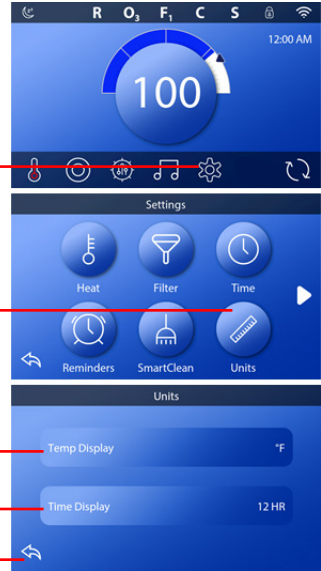

SETTING THE HEAT SETTINGS

Making changes to the heat settings will allow for a reduction in potential operating costs should you expect to not use your unit for extended periods of time.

- Ready mode will allow your spa to heat at all times it may need to.
- Rest mode only heats during a filtration mode to conserve energy.
- M8 is a automatic learning mode that helps conserve energy based on usage patterns.

To access the screen to make any changes, please follow these instructions.

1. On the home screen, touch the Settings icon located on the bottom of the display
2. Touch the Heat button
3. Touching the "Heat Mode" window allows you to toggle between Ready and Rest.
4. Touching the "M8" window toggles it on and off.
5. To save and return to the home screen, press the back button two times.

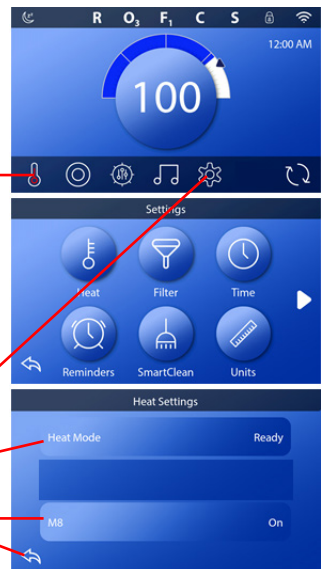

HOT TUB CONTROLS



TURNING ON REMINDERS

Reminders can be helpful to automatically notify you when general maintenance items needs to be checked. Because usage patterns can vary widely from one owner to another, the reminders are turned off by default. Below is a list of reminders that will become active if turned on.

- Check Sanitizer
- Change Cartridge
- Clean Filter
- Change Filter

To access the screen to turn reminders on or off, please follow these instructions.

1. On the home screen, touch the Settings icon located on the bottom of the display.
2. Touch the Reminders button.
3. Touching the Reminders window allows you to toggle between on and off.
4. To save and return to the home screen, press the back button two times.

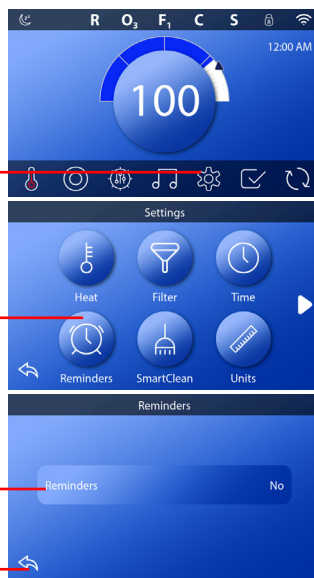

HOT TUB CONTROLS



SETTING THE LANGUAGE

The control panel is able to display the following languages

- English (Factory Default)
- Spanish
- German
- French
- Swedish

To access the screen to make any changes, please follow these instructions.

1. On the home screen, touch the Settings icon located on the bottom of the display
2. Touch the Language button



3. Touch inside the Language box to open the selection screen

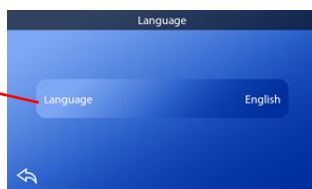

4. Use your finger to scroll up or down through the various language choices. To make a selection, move the chosen language to line up between the two black arrows. Once there, touch the "check" box on the upper right hand corner of the screen to select. You may also touch the "X" to cancel the selection. Use the back button to return to the home screen.



SETTING THE PANEL DISPLAY

You can make changes to how long the panel stays illuminated as well as altering the user control sequence for waking the panel up.

To access the screen to make any changes, please follow these instructions.

1. On the home screen, touch the Settings icon located on the bottom of the display
2. Touch the Panel button
3. Touching the “Screen sleeps after” button will open a secondary window allowing you to choose between 1 and 5 minutes of screen-on-time. Once the secondary window opens up, use your finger to scroll up and down to select the time. Once selected, touch the “check” mark to accept or the “X” to cancel.
4. Touching “Swipe to Wake” toggles between multi-touch screen waking or just one touch. In situations where large amounts of water are present, the multi-touch sequence is recommended.
5. To save and return to the home screen, press the back button two times.

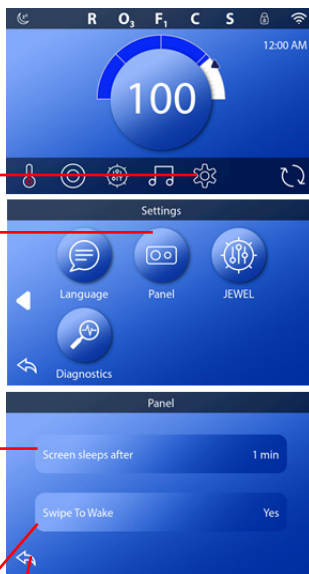

HOT TUB CONTROLS



VIEWING DIAGNOSTICS

This feature can be useful when reviewing system information or any fault codes or occurrences that may have happened during operation. Additionally you can run periodic GFCI tests to ensure the electrical supply system is operating properly.

To access this feature, please follow these instructions.

1. On the home screen, touch the Settings icon located on the bottom of the display
2. Touch the Diagnostics button
3. Touching any of the three available buttons will open up screens allowing you to view and scroll through current information on the system. In the GFCI screen, you can touch the “test” button to automatically test the GFCI. You will have to reset your circuit breaker after performing this test to turn power back on to your spa.
4. To return to the home screen, press the back button two times.

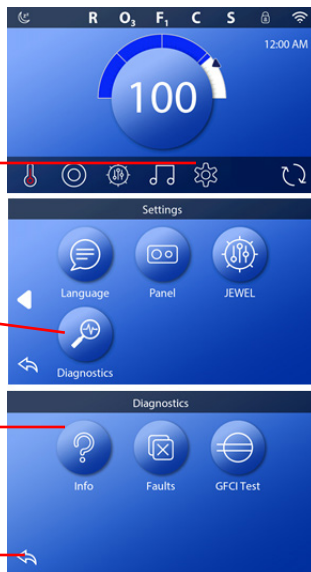

CONTROLLING SPA FUNCTIONS

Access to spa functions are assembled on one easy to use screen. Controlling the pumps, lights, and other features can be done as desired by the user in the spa control screen.

To access this feature, please follow these instructions.

1. On the home screen, touch the double circle icon located on the bottom of the display
2. When the “Spa” screen appears, simply touching each button will activate the function as follows.



Jets 1: Unless already on due to a heating or filtration cycle, touching this button once will turn on low speed. You will know it is on when a white ring around the button is present. Touching the button a second time will turn the pump on to high speed. You will see the internal jet bubble icon increase in size. Touching the button again will turn the pump off. If left on, high speed will run for 15 minutes and then switch down to low speed for 15 minutes before turning off. In some cases the pump will continue to run on low speed for filtering or heating.

HOT TUB CONTROLS



Jets 2: If equipped, touching this button once will turn on to low speed. You will know it is on when a white ring around the button is present. Touching the button a second time will turn the pump on to high speed. You will see the internal jet bubble icon increase in size. Touching the button again will turn the pump off. If left on, high speed will run for 15 minutes and then switch down to low speed for 15 minutes before turning off.

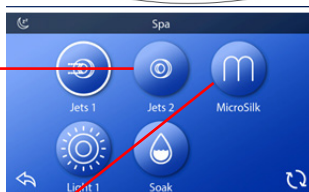

MicroSilk®: If equipped with this option, touching the MicroSilk button will turn on this special feature and run for 30 minutes. You will know it's on when a white ring is present around the button. Note that all other pumps will shut off after a few minutes in order for the feature to work as designed. Touching the button again will turn off the feature and allow control of the other pumps to be resumed.

Light: Touching this button will turn on the interior LED lights. Touching this button repeatedly will cycle through an array of colors options. Touch the button to turn off the lights at any point. If left on, the lights will automatically turn off after 60 minutes. The button will have a white ring around it when it has been turned on.

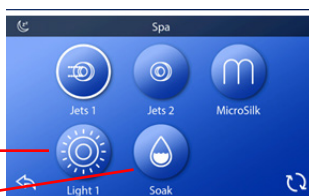

Soak: Touching this button will turn off all pumps that may be running at the time and you will know the feature has been activated when it has a white ring around the button. This feature allows the user to soak in completely still water if they choose. Light functions will continue to operate without disturbing this feature. If selected, the soak function will continue for 60 minutes and then automatically resume normal operation. Simply pressing any of the pump buttons will override the soak feature and resume normal operation. Note: Because no pumps run while the soak feature is on, heating of the water will not occur.

Pressing the back button will take you back to the home screen.



HOT TUB CONTROLS



BLUETOOTH AUDIO (OPTIONAL)

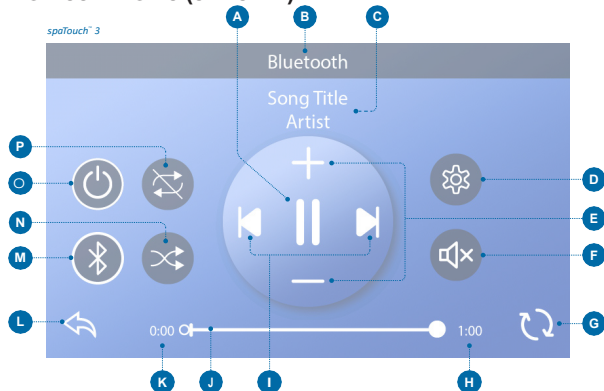

- A- Play/Pause
- C - Song Title, Artist
- E- Volume Up/Down
- G- Invert Display
- I - Track Next/Previous
- K - Elapsed Time
- M- Input Modes: Bluetooth, Line In
- O - Power

- B- Bluetooth Screen
- D - Settings
- F - Mute Control
- H- Remaining Time
- J- Progress Bar
- L - Back
- N- Shuffle Control
- P- Repeat Control

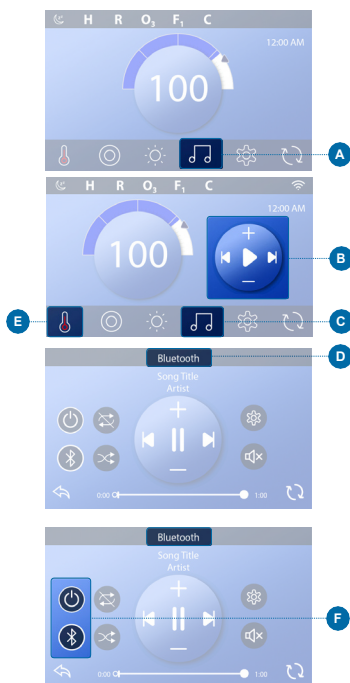

NAVIGATE TO THE BLUETOOTH SCREEN

Follow these steps to navigate to the Bluetooth screen (D).

If connected to a music source:

- 1- Press the Music button (A) to view the Mini Player (B).
- 2- Press the Music button again (C) to enter the Bluetooth screen (D).

If not connected to a music source:

- 1 - Press the Music button (A) to enter the Bluetooth screen (D).

About the Mini Player:

The Mini Player (B) controls play, pause, track forward/back, and volume up/down.

Hide the Mini Player by pressing the Heater Status button (E) twice. The first press displays the Set Temperature/Time in the Mini Player. The second press hides the Mini Player.

NOTE: If these buttons (F) appear and both have white circles as shown here, your music source is connected. If they appear as shown except either one of them does not have a white circle, your music source is not connected.

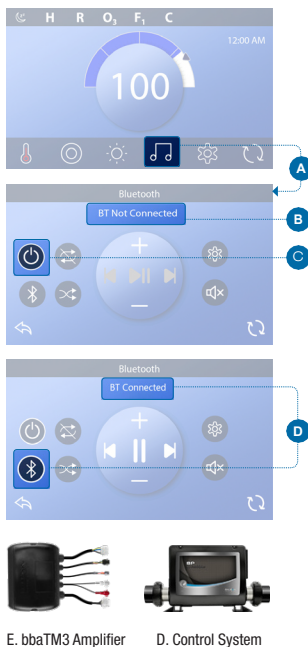

PAIR SMART DEVICE

Follow these steps to pair your smart device with the bbaTM3 amplifier (E).

1. Power up the spa.

IMPORTANT: All paired devices are erased from the bbaTM3 amplifier when power to the spa is cycled. While the bbaTM3 amplifier forgets your smart device when the spa power is cycled, your smart device might not forget the bbaTM3 amplifier. In this case, an error message may appear if you try to reconnect. You may need to have your smart device “forget” the bbaTM3 amplifier, and only after that connect to the bbaTM3 amplifier again to avoid such error messages.

2. Press the music button (A) to enter the Bluetooth screen. The music button (A) may not appear if control system (F) did not detect the bbaTM3 amplifier (E).
3. Press the power button (C) to turn On the bbaTM3 amplifier. This message will appear (B) when your smart device is not connected/paired with the bbaTM3 amplifier. “BT” stands for Bluetooth.
4. On your smart device, turn On the Bluetooth function.
5. On your smart device, click search for Bluetooth device. Make sure the smart device is close enough to the spa tub, so the smart device can pair with the bbaTM3 amplifier.
6. On your smart device, select “BBA Spa Music” from the pairing list. If “BBA Spa Music” does not appear, repeat steps 1 - 5.
7. Some smart devices will connect automatically, but with others you will need to select “Connect.” Once connected, a white ring appears around the Bluetooth button and “BT Connected” appears at the top of the screen (D). Play music on your smart device. If the music plays from the speakers in the spa, the connection is complete.

NOTE: bbaTM3 operates up to 100 feet in open air. Ranges vary as they are dependent on installations and environments.

spaTouch 3



There are two types of filters: Low Pass and High Pass. These filters apply to the rear speaker output only. Select Low Pass for subwoofers or High Pass for tweeters. Select OFF if filtering is not desired. Regular speakers do not require filtering.

ADJUST AUDIO SETTINGS

Follow these steps to adjust the audio settings.

1. Navigate to the Bluetooth screen (A); refer to page 4.
2. Press the Settings button (B) to enter the Settings screen.
3. Make desired changes to the audio settings.

SELECT INPUT MODE

The following input modes are available: Bluetooth, Line In. All control systems are equipped with Bluetooth mode. However, control systems may or may not have Line In, as this input mode is optional.



Follow these steps to select the input mode of the bbaTM3 amplifier.

1. Navigate to the Bluetooth screen (A); refer to page 4.
2. Confirm that the bbaTM3 amplifier is turned On. If it is On, a white ring appears around the Power button (B).
3. Press the Input button (C). If the Bluetooth input mode is selected, this appears (C or D). If the Line In input mode is selected, this appears (E and F).

If you select the Line In input mode (F), you can connect any headphone output to the Aux In connectors (H), but you will likely need an adapter cable because of the different connectors.

Only those settings which remain on the Line In screen (E) are available when using Aux In (H).

The terms "Line In" (E) and "Aux In" (H) refer to the same thing.

The Mini Player (G) on the Main screen looks like this when Line In is the selected input mode. For more information about the Mini Player, view page 4.

HOT TUB CONTROLS



JEWEL™ LIGHTING CONTROLS (OPTIONAL)

Jewel Lighting is an optional feature that allows for expanded control of the interior lighting and added exterior cabinet light control.

To access this feature, please follow these instructions.

1. On the home screen, touch the Settings icon located on the bottom of the display to access the light control screen.

(A) Main Power button. Pressing this button will turn all Lights on or off. If lights are on, there will be a white ring around the button.

(B) Zone selection. Pressing the arrow to the right will take you To the Zone B, exterior light operation screen.

(C) Dimmer Control: Pressing repeatedly will dim the brightness of the lights until they are off. Pressing again will start the cycle over.

(D) Timer control: Pressing this button will either speed up or slow down the transition of the light patterns.

- Light patterns: Beginning from the left, color wheel, Party, or Lounge.
- Pressing a button during the cycle will pause the pattern.

(F) Colors: Pressing a specific color will give you direct access color changes.



ZONE B: EXTERIOR CABINET LIGHT CONTROLS (OPTIONAL)

(A) Main Power button. Pressing this button will turn all Lights on or off. If lights are on, there will be a white ring around the button.

(B) Zone selection. Pressing the arrow to the left will take you To the Zone A, interior light operation screen.

(C) Dimmer Control: Pressing repeatedly will dim the brightness of the exterior lights until they are off. Pressing again will start the cycle over at the brightest setting.

NOTE: Exterior corner lighting is white only.

(D) Pressing the back button will take you to the home screen.

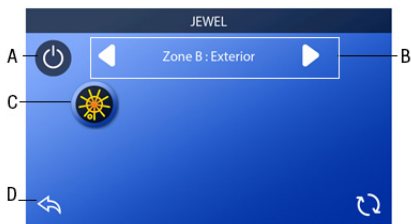

MESSAGE BUTTONS

Message buttons provide reminders to help you keep your spa running smoothly. Message buttons also provide warning information that helps spa technicians with troubleshooting.

When a message button appears (C), press it to view the corresponding message (D) or (G). Press the Exit button (E) to go back to the Main screen, or press the Clear button (F) to dismiss the message.

Buttons vary depending on the type of message. View the list below.

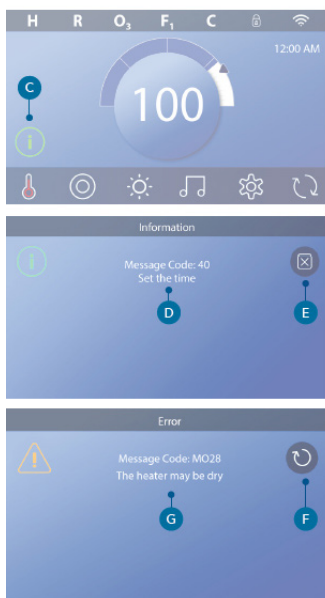
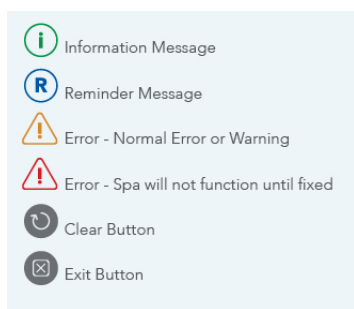

MESSAGES

General Messages

Several alerts and messages may be displayed in a sequence.

Possible freezing condition

A potential freeze condition has been detected, or the Aux Freeze Switch has closed. All water devices are activated. In some cases, pumps may turn on and off and the heater may operate during Freeze Protection. This is an operational message, not an error indication.

The water is too hot – M029*

The system has detected a spa water temp of 110°F (about 43°C) or more, and spa functions are disabled. System will auto reset when the spa water temp is below 108°F (about 42°C). Check for extended pump operation or high ambient temp.

The water level is too low

This message can only appear on a system that uses a water level sensor. It appears whenever the water level get too low (or the water level sensor is disconnected), and automatically disappears when the water level is adequate. Pumps and the heater turn OFF when this message appears.

HEATER-RELATED MESSAGES

The water flow is low – M016**

There may not be enough water flow through the heater to carry the heat away from the heating element. Heater start up will begin again after about 1 minute. See “Flow Related Checks” below.

The water flow has failed* – M017**

There is not enough water flow through the heater to carry the heat away from the heating element and the heater has been disabled. See “Flow Related Checks” below. After the problem has been resolved, reset the message*.

The heater may be dry* – M028**

Possible dry heater, or not enough water in the heater to start it. The spa is shut down for 15 minutes. Reset this message* to reset the heater start-up. See “Flow Related Checks” below.

The heater is dry* – M027**

There is not enough water in the heater to start it. The spa is shut down. After the problem has been resolved, you must reset the message* to restart heater start up. See “Flow Related Checks” below.

The heater is too hot* – M030**

One of the water temp sensors has detected 118°F (about 48°C) in the heater and the spa is shut down. You must reset the message* when water is below 108°F (about 42°C). See “Flow Related Checks” below.

Flow-related checks

Check for low water level, suction flow restrictions, closed valves, trapped air, too many closed jets and pump prime. On some systems, even when spa is shut down by an error condition, some equipment may occasionally turn on to continue monitoring temperature or if freeze protection is needed.

SENSOR-RELATED MESSAGES

Sensors are out of sync – M015**

The temperature sensors may be out of sync by 3°F. Call for Service if this message does not disappear within a few minutes. Sensors are out of sync -- Call for service*

– M026**

The temperature sensors ARE out of sync. The fault above has been established for at least 1 hour. Call for service.

Sensor A Fault, Sensor B Fault

– **Sensor A: M031****, **Sensor B: M032****

A temperature sensor or sensor circuit has failed. Call for service.

SYSTEM-RELATED MESSAGES

Program memory failure* – M022**

At Power-Up, the system has failed the Program Checksum Test. This indicates a problem with the firmware (operation program) and requires a service call. The settings have been reset.

(Persistent Memory Error)* – M021**

Contact your dealer or service organization if this message appears on more than one power-up.

The clock has failed* – M020**

Contact your dealer or service organization.

Configuration error

The spa will not Start Up. Contact your dealer or service organization.

The GFCI test failed

(System Could Not Test the GFCI) – M036**

(North America Only) May indicate an unsafe installation. Contact your dealer or service organization.

A pump may be stuck on – M034**

Water may be overheated. POWER DOWN THE SPA. DO NOT ENTER THE WATER. Contact your dealer or service organization.

Hot fault – M035**

A Pump Appears to have been Stuck ON when spa was last powered. POWER DOWN THE SPA. DO NOT ENTER THE WATER. Contact your dealer or service organization.

REMINDER MESSAGES

Reminder messages can be reset from the panel. Press the Clear Icon to reset the Reminder message.

General maintenance helps

Reminder Messages can be suppressed by using the Reminders Screen.

Check the sanitizer

May appear on a regular schedule, i.e. every 7 days. Check sanitizer level and other water chemistry with a test kit and adjust with the appropriate chemicals. You may set a reminder in the Reminders screen to check consistently on your sanitizer levels. The reminder does not measure if the actual sanitizer level is low or high, just that you should test appropriately.

Clean the filter

May appear on a regular schedule, i.e. every 14 days. Clean the filter media as instructed by the manufacturer.

Change Cartridge

May appear on a regular basis. Set a reminder and replace mineral cartridge after 120 days. You may feel material inside the cartridge however, this material is spent and will no longer work in conjunction with your sanitizer.

Change the water

May appear on a regular schedule, i.e. every 90 days. Change the water in the spa on regular basis to maintain proper chemical balance and sanitary conditions. You may want to set a reminder to purge, drain and fill your hot tub every 90 days to avoid total dissolved solids buildup in your water which can render your sanitizer ineffective.

Change the filter

May appear on a regular schedule, i.e. every 180 days. Filters should be replaced occasionally to maintain proper spa function and sanitary conditions. Filters should be inspected for wear, tear or damage every 180 days to assure your hot tub is functioning properly.

MISCELLANEOUS MESSAGES

Set the Time-of-Day

When a control system that displays this message is powered On, its time-of-day is initialized to 12:00 PM. Setting the proper time-of-day is important for determining filtration times and other background features.

Communications error

The control panel is not receiving communication from the System. This can appear briefly during system start-ups. This is normal. If it does not go away quickly, Call for service.

Test software installed

The Control System is operating with test software. Call for service.

MESSAGE NOTES

Some messages include the "Call for Service" text as it requires a service technician to fix the problem.

If the panel is locked and a message alert appears, you will be taken to the Lock Screen (where you will need to Unlock the panel) before you can clear the message.

Touching the Error/Warning/Reminder/Info Icon on the Message Screen will take you to the System Information Screen to allow for troubleshooting over the phone or for a field service tech to better understand what is going on. Exiting the System Information Screen will take you back to the Message Screen in that situation.

SUMMIT

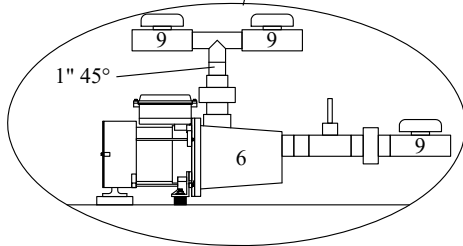
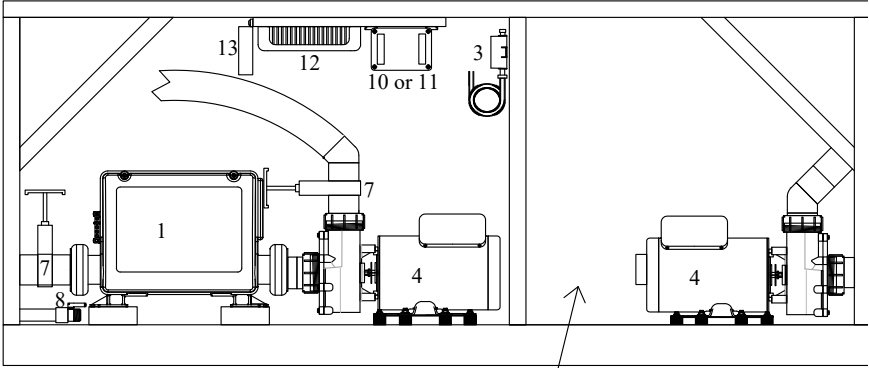

Microsilks Option

#	Component	Quantity
1	Control Box and Heater	1
3	Ozonator	1
4	Pumps	2
6	MicroSilk® pump (option)	1
7	Slice Valves	2
8	Drain Valve	1
9	MicroSilk shut off valve (option)	3
10	Light Driver	1
11	Jewel™ LED Control (option)	1
12	Bluetooth Audio (option)	1
13	ControlMySpa™ Module (option)	1

EPIC & EUPHORIA

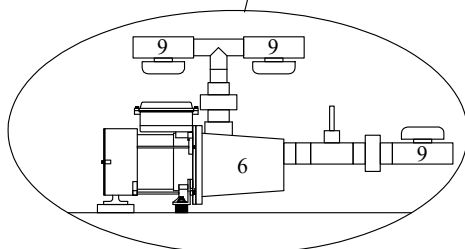
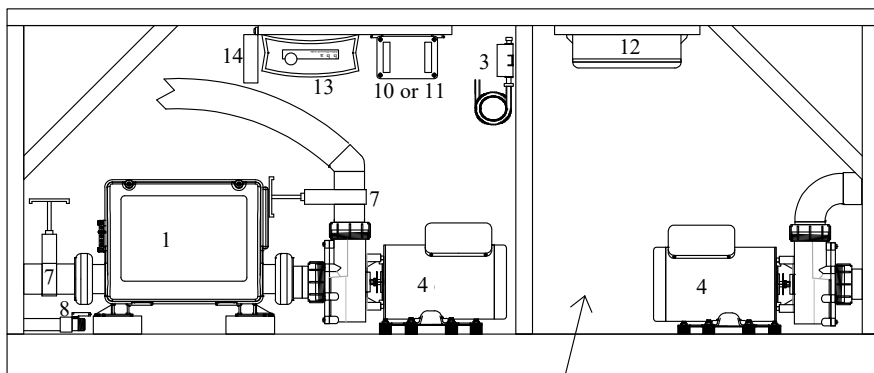

Microsilks Option

#	Component	Quantity
1	Control Box and Heater	1
3	Ozonator	1
4	Pumps	2
6	MicroSilk® pump (option)	1
7	Slice Valves	2
8	Drain Valve	1
9	MicroSilk shut off valve (option)	3
10	Light Driver	1
11	Jewel™ LED Control (option)	1
12	Bluetooth Audio (option)	1
13	ControlMySpa™ Module (option)	1

RESORT

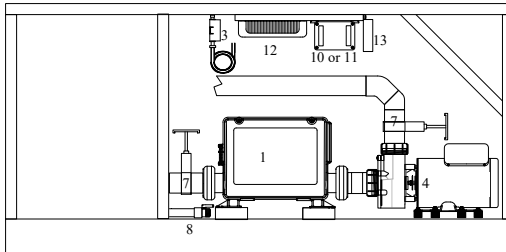

Auxiliary Pump location on left side of spa when standing at the control panel

MicroSilk Pump location on right side of spa when standing at the control panel

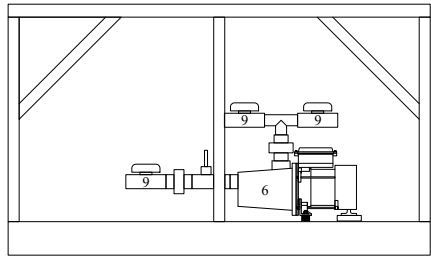
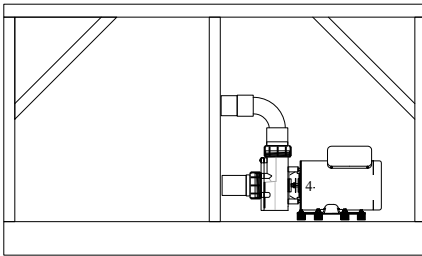

#	Component	Quantity
1	Control Box and Heater	1
3	Ozonator	1
4	Pumps	2
6	MicroSilk® pump (option)	1
7	Shut Off Valves	2
8	Drain Valve	1
9	MicroSilk shut off valves (option)	3
10	Light Driver	1
11	Jewel™ LED Control (option)	1
12	Bluetooth Audio (option)	1
13	ControlMySpa™ Module (option)	1

DESTINY

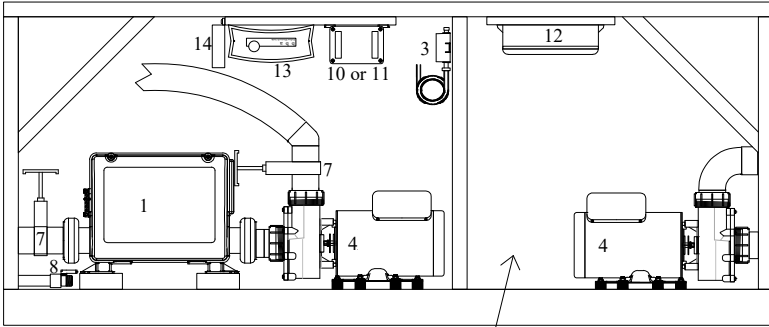

MicroSilk Option

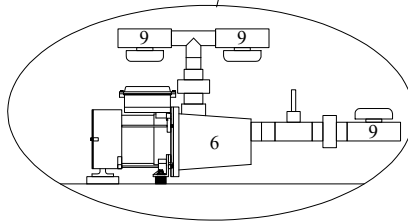

#	Component	Quantity
1	Control Box and Heater	1
3	Ozonator	1
4	Pumps	2
6	MicroSilk® pump (option)	1
7	Slice Valves	2
8	Drain Valve	1
9	MicroSilk shut off valves (option)	3
10	Light Driver	1
11	Jewel™ LED Control (option)	1
12	Bluetooth Audio (option)	1
13	ControlMySpa™ Module (option)	1

WISH 1-PUMP

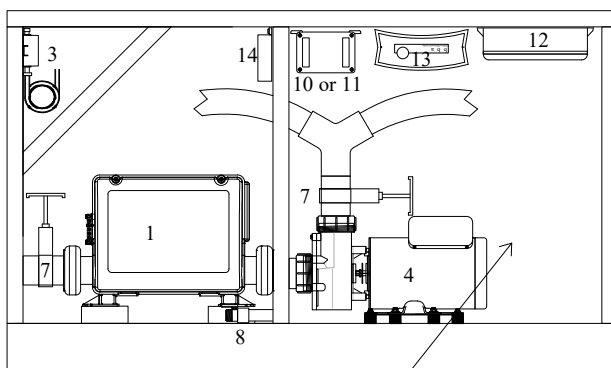

MicroSilk Option

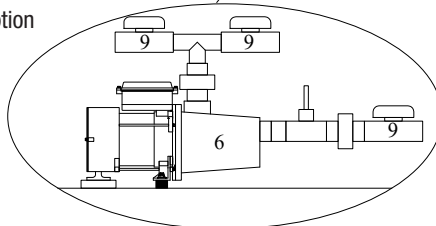

#	Component	Quantity
1	Control Box and Heater	1
3	Ozonator	1
4	Pump	1
6	MicroSilk Pump (option)	1
7	Slice Valves	2
8	Drain Valve	1
9	MicroSilk Shutoff Valve (option)	1
10	Light Driver	1
11	Jewel™ LED Control (option)	1
12	Bluetooth Audio (option)	1
13	ControlMySpa™ Module (option)	1

WISH 2-PUMP

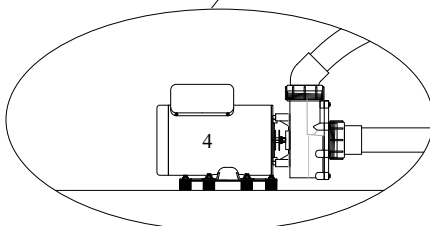
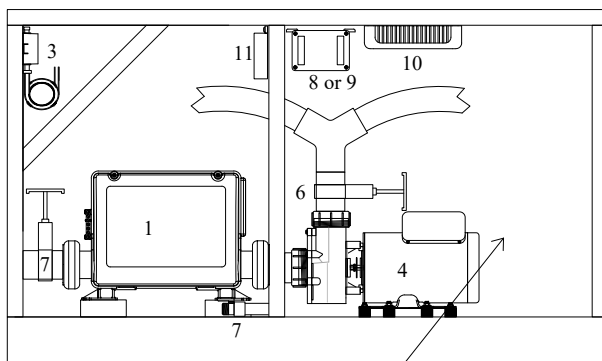

Pump 2

#	Component	Quantity
1	Control Box and Heater	1
3	Ozonator	1
4	Pumps	2
6	Slice Valves	2
7	Drain Valve	1
8	Light Driver	1
9	Jewel™ LED Control (option)	1
10	Bluetooth Audio (option)	1
11	ControlMySpa™ Module (option)	1

SPIRIT

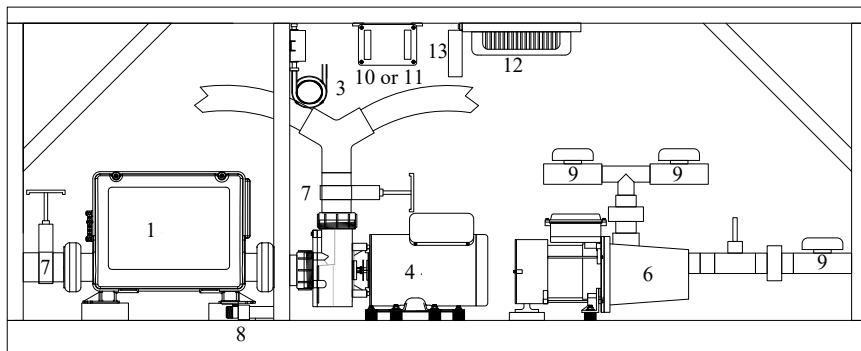

#	Component	Quantity
1	Control Box and Heater	1
3	Ozonator	1
4	Pump	1
6	MicroSilk® pump (option)	1
7	Slice Valves	2
8	Drain Valve	1
9	MicroSilk shut off valves (option)	3
10	Light Driver	1
11	Jewel™ LED Control (option)	1
12	Bluetooth Audio (option)	1
13	ControlMySpa™ Module (option)	1

HOW TO PROLONG THE LIFE OF YOUR HOT TUB

Please follow the guidelines listed below to ensure the most trouble free and enjoyable use of your spa.

Rinse your feet

Please remember to rinse your feet before getting into the hot tub. This will help prevent sand and dirt from entering the plumbing system where it can clog valves and filters.

Use a suction sock

Please also use a suction sock to further reduce the amount of debris that can enter the plumbing system.

Keep the cover on

Always keep your hot tub cover closed when the spa is not in use. This helps prevent unwanted debris from entering the hot tub and prevents sun exposure that could damage the surface and the jets of the hot tub. For full warranty coverage, please note the spa must remain covered at all times when not in use.

Keep the water clear and balanced

Water chemistry is another important part of spa ownership. Please be sure to use only factory recommended products. In addition, please make sure you maintain proper pH and sanitizer levels. Drain and refill your hot tub with fresh water every 3 to 4 months. On a regular basis, please use a spa vacuum to remove dirt and sand that can be seen on the floor of the hot tub.

WEEKLY MAINTENANCE

Removing Debris

Remove any debris and leaves from the Vortex skimmers and suction guard(s) on the inside of the spa. Blocked intakes can impede the flow of water through the jetting system.

Water Level

Replenish the water level if necessary so that it is approximately two-thirds up the Vortex skimmer opening. (See STARTING YOUR SPA.) Low and high water levels can damage your spa. It is important to check your water level often.

MONTHLY MAINTENANCE

Filter Care

We cannot stress enough the importance of a clean filter for proper water filtration. Dirty filters can restrict water flow, cause hazy water, and prevent your chemicals from working properly. Dirty filters can also cause low flow from jets, poor water clarity and sensors to activate error codes. It is important to clean filters regularly. Many water treatment products clear or clarify the water by clumping microscopic particles and minerals together so that these larger particles can be effectively trapped in the filter. A filter clogged with debris and calcium deposits does not trap particles properly. Soak your filter cartridges in *Filter Cleaner* monthly.

Removing the Filter

1. Remove filter cover.
2. Twist filter counter-clockwise and lift filter out.

Reinstalling the Filter

Repeat above directions.

CAUTION: Overtightening of the filter can cause the filter or filter housing to crack. Tighten filter until it is just snug.

NOTE: Filters and filter lids do not qualify for labor coverage. These parts can be purchased or exchanged under warranty at your authorized Marquis® dealer.

Leakage Detection

Open the equipment door and check for signs of water leakage around the pump(s). Pump seals wear out over time, especially with improper water chemistry. Early detection of pump seal failure can significantly reduce repair costs. Pump seals, heater gaskets and pump gaskets must be checked each month to ensure they are not leaking. Further damage caused by a leak from any component is not covered under the warranty.

EVERY THREE TO FOUR MONTHS

Draining and Filling the Spa

The average spa needs to be drained every three to four months. After months of continually adding chemicals to the water and introducing body oils and lotions, the water can be difficult to manage and chemicals are not as effective as usual. You may also notice excessive foaming. More frequent draining may be required depending on use.

Draining the Spa

1. Turn off the power to the spa.
2. Open the equipment compartment (see EQUIPMENT DIAGRAM). Remove the hose bib cap from the connection and attach a hose.
3. Open the drain valve. Gravity causes the water to drain out of the hose.
4. When the spa is empty, close the drain valve and remove the hose. Reinstall the hose bib plug.

NOTE: Keep the drain valve closed at all times except when draining the spa (do not rely on the cap to stop the flow of water). Not doing so could result in damage to the drain valve due to freezing water.

Replacing the Mineral Cartridge

The *In-line mineral cartridge* should be replaced every three to four months. You may still feel the “spent” minerals inside, but they are no longer effective and need to be replaced. (See ADJUST THE MINERAL CARTRIDGES, Blue Mineral Cartridge.)

Clean the DuraShell® Interior

Once the spa is drained, clean the DuraShell interior thoroughly – especially at the water line. We suggest the *Glove Sponge* to clean without scratching.

Marquis® Gloss & Guard or *Spa Brite* is the recommended cleaning agent for DuraShell – other products should be avoided except as stated below.

To maintain the high gloss and elegant look of DuraShell®, just follow these simple steps: For normal care and cleaning use a soft cloth or sponge and water. Rinse well and dry with a soft, clean cloth. Never use abrasive cleaners. Do not allow your acrylic surface to come into contact with products such as ammonia (Windex) ketones or esters such as acetone or ethyl acetate (nail polish remover), Wintergreen oil (methyl salicylate), nail polish, dry cleaning solution or other chlorinated organic solvents, lacquer thinners, gasoline, aromatic solvents, citrus cleaners, pine oil, etc. Remove dust and dry dirt with a soft, damp cloth. Clean grease, oil, paint and ink stains with diluted isopropyl (rubbing) alcohol (do not let alcohol pool or remain on acrylic). Dry with a clean, soft cloth. Avoid using razor blades or other sharp instruments that might scratch the surface.

NOTE: Due to the high-gloss, fine finish of the acrylics, imperfections in the surface texture may occur. A natural aging process in acrylic can lead to a process called crazing. Fine spider web-like lines can form on the cosmetic surface of acrylic over time after exposure to the elements and chemicals.

Crazing represents no structural weakening of acrylic and is not covered under the warranty. Fading, staining and discoloration may also occur but represent no structural degradation and are not covered under warranty.

NOTE: Do not leave an empty spa uncovered. Direct sunlight on the spa surface can cause severe damage or blemishing, cause fittings to discolor and can result in the voiding of any surface warranties.

Refill the Spa

Fill the spa with fresh water from a garden hose and balance the water as described in the Water Treatment section. The use of a *Fill Filter* is recommended when filling especially in areas of high mineral content in the water. Attach to the end of a garden hose to filter out any grit and sediment that could accumulate in the spa and potentially scratch the spa surface.

AS NEEDED MAINTENANCE

Weather Shield™ Cover Care

Weather Shield is a solution dyed polyester fabric designed to be flexible and easy for manufacturers to use. Its urethane coating enhances the stability of the weave and allows for greater water resistance, while also minimizing shrinkage and stretching. Weather Shield features a high UV, water and mold and mildew resistance and has excellent tear and abrasion resistance.

Care & Cleaning

Weather Shield is designed to be easy to maintain. It can be washed, or brushed off and rinsed. Proper care and cleaning is important to the life of all fabrics.

For Normal Care and Cleaning

- Add 2 ounces of mild soap such as Woolite or Dawn dishwashing liquid to 1 gallon of lukewarm water.
- Clean the fabric with a “soft bristle brush.”
- Rinse thoroughly with cold water and air dry.

For Stubborn Stains

- Add maximum 1 cup of bleach to one 1 gallon of water.
- Spray on lightly to the fabric face (non-coated side). Do not soak fabric.
- Prolonged exposure to harsh chemicals can damage the coating.
- Rinse immediately. Do not leave on for more than 2 minutes.
- Cleaning with harsh cleaners such as bleach will require a retreatment like 303 High Tech Fabric Guard for restoring water repellency.

Cushioned Headrest Care

To increase the life of your cushioned headrest, remove and replace them with care only when necessary.

Remove Cushioned Headrest

Slip your fingers under each end of the interior cushioned headrest part and gently pull straight towards you. Damage caused to attachments due to improper removal is not covered under warranty. Pillows and attachments are warranted to be free of defects at delivery only.

Exterior Care

Clean the exterior of the spa with a mild soap and water solution. Cleaners that contain alcohol or high levels of solvents, along with Acetone, Nitrobenzene, and Cyclohexanol, can dissolve and discolor the exterior.

Excess Debris

Grit and debris tracked into the spa should be removed with a spa vacuum.

Water Line

To avoid buildup of oils and lotions at the water line, clean the interior weekly or when needed. We suggest the Glove Sponge to clean without scratching.

NOTE: Do not use the same brush or sponge to clean the exterior of the spa and the interior of the spa. Soap and other product residue used on the outside of the spa can cause foaming of the spa water and scratches to the spa surface if used on the inside of the spa.

SUSPENDED USE OR WINTERIZING THE SPA

If you decide to discontinue the use of your spa for any extended period of time, we suggest you follow the steps below.

NOTE: During long periods of inactivity, damage can occur to equipment from condensation within the equipment compartment. Failure to follow these instructions during freezing conditions will result in cracked fitting(s) and glue joints, and other damage.

1. Turn off the power to the spa.
2. Drain the spa. (See DRAINING AND REFILLING THE SPA.)
3. Remove all residual water from the seating and footwell. If necessary, bail out the remaining water then dry the spa with towels. A wet/dry vacuum is recommended for best results.
4. Using the wet/dry vacuum, place vacuum nozzle over each jet nozzle to remove water from plumbing lines, starting with the highest jet and finishing with the lowest jet. **NOTE:** Be sure to switch the valve diverter from one position to the secondary to vacuum the color coded jetfaces.
5. Unscrew the pump plug(s) from the pump(s).
6. Again, using the wet/dry vacuum, place nozzle over the exposed pump opening(s) to remove excess water. The pump(s) should be removed from the spa and stored in a climate-controlled room.
7. Clean the spa interior.
8. Clean the filter cartridges.
9. Reinstall the cover and lock in place. **NOTE:** Direct sunlight on the spa surface can cause severe damage or blemishing and can result in the voiding of any surface warranties.

VACATION CARE INSTRUCTIONS

Short time periods: 3-5 days

1. Adjust the pH (see WATER CARE).
2. Sanitize the water by following the shock procedures (See WATER CARE).
3. Lock your spa cover in place with cover locks.
4. Upon return, shock sanitize water.

Long time periods: 5-14 days

1. One day before leaving, set the temperature to approximately 80°F (27°C).
2. Adjust pH as needed.
3. Shock sanitize water.
4. Upon return, shock sanitize water.
5. Return temperature to original setting.
6. Test water chemistry and adjust as necessary.

IMPORTANT CHEMICAL SAFETY PROCEDURES

1. Always keep chemicals out of reach of children.
2. Read product labels carefully prior to use.
3. When dissolving, always add chemicals to water, do not add water to chemicals. Some dry chemicals should be dissolved prior to adding them to the spa. Using a clean container, dip some water from the spa. Mix until dissolved, then add to circulating water.
4. **CAUTION:** Do not mix chemicals together. Add them separately to the spa water.
5. All chemical products should be stored in a cool, dry, well-ventilated area where the average temperature does not exceed 90°F (32°C). Keep storage area clean of debris such as rags, newspaper, and combustible materials.
6. Keep chemicals away from open flame or other heat source. Do not smoke near chemicals. If a dry chlorine chemical fire should occur, use water only. Do not use a dry chemical fire extinguisher to attempt to put out the fire.
7. When adding chemicals, always keep the water circulating in the spa with jets in a downward circular pattern for better chemical distribution. Add chemicals to the spa water one at a time. Allow several minutes between any new chemical additions using the jet action to evenly distribute throughout the spa.
8. It is important to leave the spa cover open for 20-30 minutes while shock treating your spa to avoid damage. Do not leave spa unattended while cover is open. Damage such as discoloration or brittle vinyl due to chemical damage is not covered under the warranty.
9. After adding chemicals, wait the amount of time recommended on the chemical container before retesting your water for an accurate reading. Retest your spa water before using.
10. If you have any questions or concerns about the correct procedures for handling chemicals, please contact your authorized Marquis® dealer.

CAUTION: Damage to the spa surface and equipment due to the use of trichlor chlorine, or other harsh chemicals not recommended by Marquis is not covered under warranty.

WATER CARE

There are three things necessary for clean safe water:

1. **CIRCULATE:** Water has to be circulated regularly; it can not be stagnant.
2. **FILTER:** Water has to be filtered to remove particulates and debris.
3. **SANITIZE:** Water has to be sanitized to kill organisms like algae, bacteria and virus.

It is critical to maintain proper water balance to protect the spa heater and other components from damage. Damage to the spa surface and equipment caused by poor chemical or harsh chemical treatment is not covered under the warranty. Discoloration of jet faces, valves and controls are an indication of poor chemical maintenance or exposure to the sun.

Jet inserts and valves do not qualify for labor coverage. These parts can be purchased or exchanged under warranty at your authorized Marquis® dealer. Gaskets and seals are not covered under the warranty. The control system in your Marquis spa will automatically circulate and filter. (See SPA CONTROL OPERATION, ConstantClean™ and SmartClean™ sections.) The sanitation requires minimal effort if done consistently and properly.

To sanitize spa water, three things are required:

1. **BALANCE:** The water must be balanced so the sanitizer can work and spa equipment is protected.
2. **SHOCK:** Shock to oxidize organics and maximize sanitizer efficiency.
3. **SANITIZE:** Maintain a proper level of sanitizer at all times.

UNDERSTANDING WATER BALANCE

Water balance is the interrelation of factors that determine the quality of the spa water. The effectiveness of chemicals and other additives are dependent on all these factors working together or “in balance”. The primary elements to water balance are the calcium hardness, total alkalinity and pH. Use water treatment products recommended for use in a Marquis spa.

pH Balance

Keeping the pH balanced is the most critical component of water balance. Calcium hardness and total alkalinity act as buffers to stabilize the pH. When they are properly adjusted, the pH will be stable and easy to maintain. The pH is a measure of the relative acidity and basicity of the water. The ideal pH range is 7.4 - 7.6. When the pH falls below 7.2, the water can become corrosive. Low pH can cause damage to metal in the control system and heater, excessive sanitizer consumption, and skin irritation. A pH above 7.8 can be scale-forming and allow metals or minerals in the water to form deposits and stain spa surfaces. pH above 7.8 can also cause eye and skin irritation.

Total Alkalinity

Alkalinity acts as a buffer to prevent the pH from changing as other substances are added to the water. Stability of the pH is directly related to the alkalinity. The alkalinity should be between 80 - 140 ppm. Alkalinity below 80 ppm makes it difficult to stabilize the pH. Alkalinity above 140 ppm may increase the pH and cause cloudy water, scaling, and decreased efficiency of the sanitizer.

Note: *Alkalinity Increaser & pH Increaser* and *Alkalinity & pH Decreaser* will affect both the pH and alkalinity. Generally, smaller additions will change the pH and have a very minor effect on the alkalinity. Larger additions will also affect the pH, but will have a much greater effect on the alkalinity. (Example: If the pH is very high and the alkalinity is within range, adding a few smaller doses of *pH and alkalinity Decreaser* instead of one large dose will reduce the pH with little effect on the alkalinity.)

Calcium Hardness

Do not use soft water in your spa. It is critical to have calcium in your water. The ideal range of calcium is between 150 – 250 ppm. The calcium hardness is normally adjusted when filling or refilling after draining the spa. High calcium levels can cause scale buildup on spa surfaces and equipment. Your spa can be protected against high calcium by using *Metal & Stain Remover* per the directions on the container. Low calcium levels can cause spa water to become highly corrosive and damaging to the equipment components and plumbing. To raise calcium levels, use *Calcium Hardness Increase*.

BALANCE

When initially filling or refilling your spa, follow these steps to achieve proper water balance.

IMPORTANT! Always follow instructions on the chemical container when adding chemicals.

1. Test the spa water using a test strip or test kit. Determine the pH and alkalinity of the water.
2. If adjustments are needed for the pH and/or alkalinity, always balance the alkalinity before balancing the pH. The product(s) you should use to adjust pH and/ or alkalinity are *pH Increase*, *Alkalinity Increaser* or *pH & Alkalinity Decreaser*. Make any additions per the directions on the bottle and then test and repeat if necessary until all readings are in the desired range.
3. Increase the calcium hardness if necessary.

SHOCK

Initial Treatment

Shock the spa using granular *Chlorine Sanitizer* or non-chlorine *Spa Shock*. Add directly to the spa per the instructions on the container. For the initial treatment, *Chlorine Sanitizer* is preferred as it will also establish a residual of sanitizer. You may shock weekly using non-chlorine shock for low chlorine usage.

Maintenance Treatment

Once bacteria and other wastes are neutralized by the sanitizer, they stay in the water unless oxidized or shocked. Often called chloramines or bromamines, they create dull, cloudy water and can cause odor and eye or skin irritation. Shock treatment rids your spa of these wastes for clear, sparkling water. Shocking with non-chlorine *Spa Shock* or granular *Chlorine Sanitizer* is recommended once a week or whenever the water appears dull or cloudy or has a strong odor. Non-chlorine *Spa Shock* allows use of the spa 15 minutes after shock treatment.

NOTE: A strong bromine or chlorine odor typically indicates the spa needs to be shocked – not that there is too much bromine or chlorine in the water. A properly balanced spa, shocked, will not have an odor.

SANITIZE**ConstantClean+™ System**

The ConstantClean+ system utilizes a combination of sanitizers to increase water quality and significantly decrease maintenance. The combination of a *In-Line Mineral Cartridge** and the factory installed ozonator greatly reduce the amount of sanitizer required. Instead of the normal 3 - 5 ppm of bromine, you may only need to maintain 1 - 2 ppm of bromine.

NOTE: The use of *Spa Frog®* or *@ease floating cartridges* is recommended. Do not use other floating chemical dispensers or Biguanide. Damage to the spa shell and other internal components can occur.

* The built-in sanitation system is not available in some international markets. However, the ozone system is available on all spa models in all countries. Please see your dealer for recommended alternate treatment method if the built-in sanitation system is not available.

BUILT-IN SANITATION SYSTEM*

After shocking the spa water with *Chlorine Sanitizer* granules, bring the spa water to operating temperature. Then install the *In-Line cartridges*.

ADJUST THE MINERAL CARTRIDGE

Remove the protective cellophane wrap from the *In-Line mineral cartridge*. While holding the bottom of the cartridge, turn the top until the number six appears in the setting window.

NOTE: The mineral cartridge should be replaced every three to four months. You will still feel the "spent" minerals inside, but they are no longer effective and the cartridge needs to be replaced. It is recommended to drain and refill the spa at the same time you replace the mineral cartridge.

ADJUST THE BROMINE OR CHLORINE CARTRIDGE

Remove the protective cellophane wrap from the *Spa Frog® bromine* or *@ease w/Smart Chlor cartridge*. Finding the right setting for the sanitizer cartridge will require monitoring your usage for the first few weeks. Begin with an initial setting based on the chart below and monitor sanitizer levels daily for the first week or so, adjusting the cartridge by one setting per day until a 3 - 5 ppm level has been achieved. To adjust cartridge, remove from system and turn to the next highest setting if the sanitizer level is low or the next lower setting if the sanitizer level is high. The sanitizer cartridge needs to be replaced when empty between two and four weeks. Always maintain 3 - 5 ppm of bromine or chlorine.

Daily filter time	Spa Gallons			
	-250	250-300	300-400	400-500
One hour	2	2	3	4
Two hours	2	2	2	3
Four hours	1	1	2	2

INSTALL THE CARTRIDGES

Locate and remove the cartridge holder cap on the top lip of the spa. Push down and turn the holder counterclockwise to unlock. Lift holder out. Snap the *Spa Frog®* or *@ease mineral cartridge* into the area of the holder marked “MINERALS” (top portion), making sure to line up the indentation near the top of the cartridge with the raised line on the holder. Then snap the *Spa Frog® bromine or chlorine cartridge* into the area of the holder marked “BROMINE/CHLORINE”. Be sure to line up the indentation on the cartridge with the raised line on the holder. After cartridges are snapped in, return the holder, push down, and then turn clockwise to lock into place. Replace the cap.

CAUTION: Hand-tighten only; avoid over tightening; avoid bending the holder to help prevent damage to the holder. Damage caused due to improper removal or installation of chemical cartridge holder is not covered under the warranty. Cartridge holder is warranted to be free from defects at time of delivery of spa. Chemical cartridge holders do not qualify for labor coverage. These parts can be purchased or exchanged under warranty at your authorized Marquis® dealer.

REMOVE THE CARTRIDGES

Reverse above procedures to remove cartridges.

*The built-in sanitation system is not available in some international markets. See your authorized Marquis® Dealer for recommended alternate water treatment method.

WATER CARE REGIMEN

Marquis SpaCare™ products are classified by easy to follow usage guidelines. The information below indicates whether the product should be used daily, weekly, monthly, when filling, or as needed – if special water conditions arise.

DAILY

Sanitizer

Maintain 1 - 2 ppm of bromine, @ease or chlorine at all times.

WEEKLY**Spa Shock**

Sanitizer combines with bacteria and neutralizes sanitizer/bacteria on contact. However, the used sanitizer/bacteria particle is still present in the spa water. Used sanitizer in the water emits an odor and causes cloudy water. To oxidize, or rid the spa of this used sanitizer, you must shock the spa once a week. For best results, and to protect your spa cover leave the spa cover open for a minimum of 20 minutes after shocking the water.

NOTE: Additional shocking may be necessary if the spa is under heavy use. For @ease w/Smart Chlor (for use in the US only) you will only need to shock as needed or monthly.

AS NEEDED PRODUCTS

pH Increaser, Alkalinity Increaser

pH & Alkalinity Decreaser

These three products work to raise or lower the pH and alkalinity in the spa. They are only needed if the test strip indicates the levels are not in the ideal ranges.

Water Clarifier

Microscopic particles can pass through the spa filter and create cloudy water. The use of *Marquis Water Clarifier* combines these microscopic particles into larger particles that can be trapped in the filter to clear cloudy water.

Spa Defoamer

If foam appears in your spa, the action of the jets will keep it from dissipating. The use of *Marquis Spa Defoamer* instantly rids your spa water of foam.

Metal and Stain Remover

Metal and Stain Remover will remove metals such as iron and copper from spa water.

WATER CARE TROUBLESHOOTING GUIDE

NOTE: If you request a service call and no problem is found with the spa or the problem is not covered by warranty (i.e. chemical damage), you will be charged at the regular service rate.

- P: Problem
- S: Solution

Cloudy Water

- P: Inadequate filtration or dirty filter.
- S: Ensure that the filter is securely installed. Clean or replace filter. Increase the length of clean up and/or filter cycles.

- P: Water is not balanced.
- S: Test water and adjust pH, alkalinity, and sanitizer as needed. Shock to oxidize and destroy organics in the water.

- P: Unfiltered particles or chemically saturated.
- S: Use *Water Clarifier* to combine particles.

- P: High total dissolved solids
- S: Drain, clean, and refill the spa.

Chemical Odor

- P: Too many chloramines/bromamines in the water.
- S: Treat water with *Spa Shock*, then adjust sanitizer level as necessary.

- P: Dull looking water, difficult to manage. High total dissolved solids (TDS) may be the cause.
- S: Drain, clean and refill with fresh water.

Musty Odor

- P: Not enough sanitizer in water – bacteria or algae in water.
- S: Add sanitizer as necessary and shock. Readjust sanitizer level if necessary.

Yellow Water

- P: Low pH and/or low alkalinity.
- S: Test and adjust pH with *pH and Alkalinity Increase*. Adjust alkalinity if necessary.

Foaming

- P: High concentration of body oils, lotions or soaps, as well as excessive organics.
- S: Use *Spa Defoamer* and adjust pH and sanitizer as needed.

Scum Line in Spa

- P: Body oils and dirt.
- S: Use *Glove Sponge* to clean the spa. Test and adjust the sanitizer and pH if necessary. Increase the clean up cycle.

No Sanitizer Reading

- P: Sanitizer level is too low.
- S: Shock and/or adjust *sanitizer cartridge* until the sanitizer registers in the recommended range.

- P: Test strip remains “white” even after sanitizer has been added.
- S: Sanitizer level could be extremely high. It can bleach the reagents on the test strip and give a false reading. Remove spa cover and activate jets and air control. Allow jets to run for 30 minutes. Test water to see if desired level has been reached. Adjust *sanitizer cartridge* to reduce bromine or chlorine level.

High Sanitizer Reading

- P: Too much chlorine or bromine added or dispensed into the spa.
- S: Remove spa cover and activate jets and air control. Allow jets to run for 30 minutes. Test water to see if desired level has been reached. Adjust *sanitizer cartridge* to reduce bromine or chlorine level.

Eye or Skin Irritation

- P: Contaminants or excessive amount of chloramines/bromamines in water.
- S: Treat water with *Spa Shock*. Adjust sanitizer level.

- P: pH is low.
- S: Adjust as needed.

Corrosion of Metal

- P: Low pH.
- S: Adjust pH with *pH and Alkalinity Increase*.

Green Water/Algae

- P: Low sanitizer level or high pH.
- S: Adjust pH, shock and/or adjust *sanitizer cartridge* as necessary.

Erratic pH

- P: Alkalinity and/or calcium hardness are too low causing pH “bounce”.
- S: Test and adjust alkalinity and/or calcium hardness to bring them into the ideal range.

ENVIRONMENTS™ STEP INSTALLATION (OPTION)

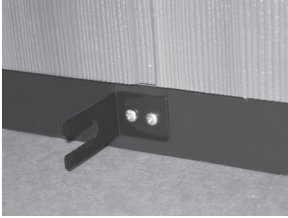

1

The step and mounting brackets may be placed along a straight side of the spa, most often centered to the entry location.

Find the center of the spa side where you want to mount the step. Measure 27.5" (699mm) center spread and mark. Measure 1" (25mm) up from base and mark (see diagram).

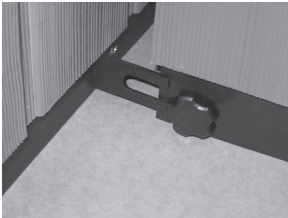

2

- With step mounting brackets facing outwards mark the two holes.
- Using the bracket as a guide, predrill two holes per bracket.
- Attach the left and right brackets to the spa exterior base (#1).
- The step hardware is factory-installed. Loosen the thumbscrew. Gently push step towards the spa until the brackets and hardware engage (#2).
- Tighten the thumbscrew to attach the step to the spa exterior (#3).

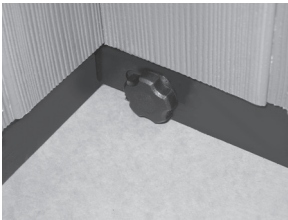

3

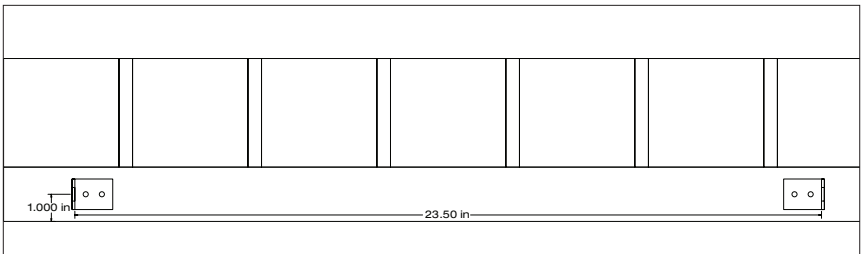

All steps can be inherently dangerous. Always use caution in stepping in and out of your spa.

- WHAT THE MARQUIS CORP. LIMITED WARRANTY COVERS** **What the Marquis Corp. Limited Warranty Covers**
 Marquis Corp. warrants that our products will be free from defects in materials and workmanship for the term set forth exclusively in this warranty. Accessories purchased from Marquis Corp. or a Marquis Corp. authorized Marquis® dealer and added to the spa after manufacture of the spa are not covered under this warranty but may have other warranties. Refer to owner's manual for proper use, maintenance and installation of your spa. The Marquis® Limited Warranty, provided by this Owner's Protection Plan, is made only to the original purchaser of the spa and is not transferable.
- 10 YEAR STRUCTURE** The reinforced structure is warranted for **10 years** not to leak. Fittings and attachments are not included.
- 7 YEAR SURFACE** The acrylic surface is warranted for **seven years** against blisters, cracks and delamination. The use of a non-Marquis® Weathershield™ cover will void this warranty.
- 5 YEAR PLUMBING** Plumbing and fittings are warranted against water loss for **five years**. Warranty coverage does not include gaskets or seals.
- 5 YEAR EQUIPMENT** Electronic equipment is warranted against defects in materials and workmanship for **five years**. Equipment includes PC boards, pumps, control panels, heater and heat sensors. MicroSilk® system and associated components has a **three year** parts and labor warranty. Audio system and associated components have a separate warranty.
- 5 YEAR EXTERIOR** The synthetic skirt and DuraBase™ exterior are warranted against cracking and peeling for **five years**.
- 2 YEAR COMPONENTS** The ozonator is warranted against defects in material and workmanship for **two years**.
- 1 YEAR PARTS** LED lights, valves, spa cover, jet inserts, in-line sanitation system and overlays are covered for **one year**. These parts do not qualify for labor coverage under this warranty.

Fuses, filter, filter lid, cushioned headrests, chemical cartridge holders and other items not specifically mentioned in this warranty are warranted to be free from defects in materials and workmanship at time of delivery. These parts do not qualify for labor coverage under this warranty.

The audio and audio components have a **one-year** warranty and includes parts and labor.

Term of the Marquis Corp. Limited Warranty

The term of your warranty begins on the date the product is sold to you and continues for the term described in this warranty for each component.

What You Should Do if You Experience a Problem

Unless otherwise designated in writing by Marquis Corp., Marquis Corp. or its agent are the only parties authorized to perform warranty service on Marquis Corp. spas. Upon experiencing a problem, please contact your authorized Marquis® dealer.

You will be asked to provide the following information when requesting warranty service: your name, address and contact information; serial number; a description of your spa and a description of the problem. You may be required to provide proof of purchase of your spa prior to receiving warranty service.

What Marquis Corp. Will Do in the Event of a Problem

Marquis Corp. agrees to repair any plumbing or surface defects and to repair or furnish a replacement for any factory-installed component covered under this warranty which, upon test and examination by Marquis Corp., proves to have manufacturing defects. All materials for examination must be returned to Marquis Corp. freight prepaid.

Marquis Corp. will provide parts and labor (according to predetermined schedule) at no charge to repair or replace components that fail due to manufacturing defects. Responding authorized Marquis® dealer may charge additional service and travel fees.

In the event that Marquis Corp. or its agent determines that your problem can be addressed by providing a replacement part to you for installation in your spa, a replacement part will be provided to you at no charge when you return the defective part. All replacement parts assume the original warranty status of the spa into which they are installed, including time remaining on warranty, and have no separate or independent warranty of any kind.

To facilitate repairs, Marquis Corp. or its agent may require access to spa equipment. It is your responsibility to provide unencumbered access.

What the Marquis Corp. Limited Warranty Does Not Cover

No warranty will apply to any spa that has been (i) modified, altered or adapted without Marquis Corp.'s written consent; (ii) maltreated or used in a manner other than in accordance with the spa Owner's Manual; (iii) repaired by any third party not authorized by Marquis Corp.; (iv) improperly installed by any party; (v) used with equipment not covered by this warranty, to the extent that problems are attributable to such use; (vi) relocated to the extent that problems are attributable to the relocation; and (vii) located on any support surface other than specified in the spa printed instructions. Other exclusions include hot tub used in any commercial application including but not limited to rental properties. Refer to instructions in the owner's manual for proper use, maintenance and installation of your spa.

Other items not included in this warranty are freight expenses; labor and material cost associated with removal and or replacement of the spa; damage to or fading of the spa surface and staining of the spa surface or equipment caused by impact, scratching, abrasive or corrosive cleaners; damage due to extreme water temperatures outside the range of 32°F to 120°F (0°C to 49°C)

under any circumstances; or damage to the spa surface or equipment caused by acts of nature, including wind and power surges. Damage to the spa surface and fittings caused by leaving the spa uncovered and empty of water with direct exposure to sunlight may cause solar heat distress and also invalidates this warranty.

Other costs not associated with the direct repair of the spa, such as phone charges and missed work are not included in this warranty. In the event that the Marquis Corp. serial number tag on the spa has been removed or tampered with, the warranty will be void. Customer may not dismantle spas, and any attempt to dismantle systems, other than described herein, constitutes a modification or alteration of the spa which voids the applicable warranty.

LIMITATIONS

Your sole and exclusive remedy and Marquis Corp.'s entire liability in connection with manufacture and sales of its spa products is repair or replacement (at Marquis' option) of a defective part, as expressed in the limited warranty. Any other express or implied representation or warranty, including the implied warranties of merchantability and of fitness for a particular purpose as well as non-infringement, is excluded to the maximum extent permitted by law.

Except as may be required by applicable law, Marquis Corp. shall not be liable for injury, loss, or damage to person or property, however arising, in connection with manufacture or sale of its spa products. This includes indirect, punitive, special, incidental, or consequential damages (including but not limited to loss of use) whether the claim for such injury, loss, or damage is based on breach of contract, breach of warranty, or tort, even if Marquis Corp. has previously been advised of the possibility of such damages.

This limited warranty gives you specific legal rights, and you may also have other rights which vary from state to state.

IMPORTANT: Some jurisdictions do not allow the exclusion or limitation of incidental or consequential damages, therefore the limitation or exclusions may not apply to you.

DISCLAIMERS

There are no additional warranties, express or implied, which extend beyond the terms of this limited warranty. Marquis Corp. makes no warranty of merchantability of the goods or the fitness of the goods for a particular purpose.

No other person or entity has been authorized to make any warranty, representation or promise of performance not included in this express written warranty, and Marquis Corp. shall not be bound by any such additional warranty, representation or promise.

This warranty gives you specific legal rights. You may also have other rights that may vary from state to state.